



ENGINEERING DATA

Bulletin No. 490136

October 2009

Supersedes September 2009

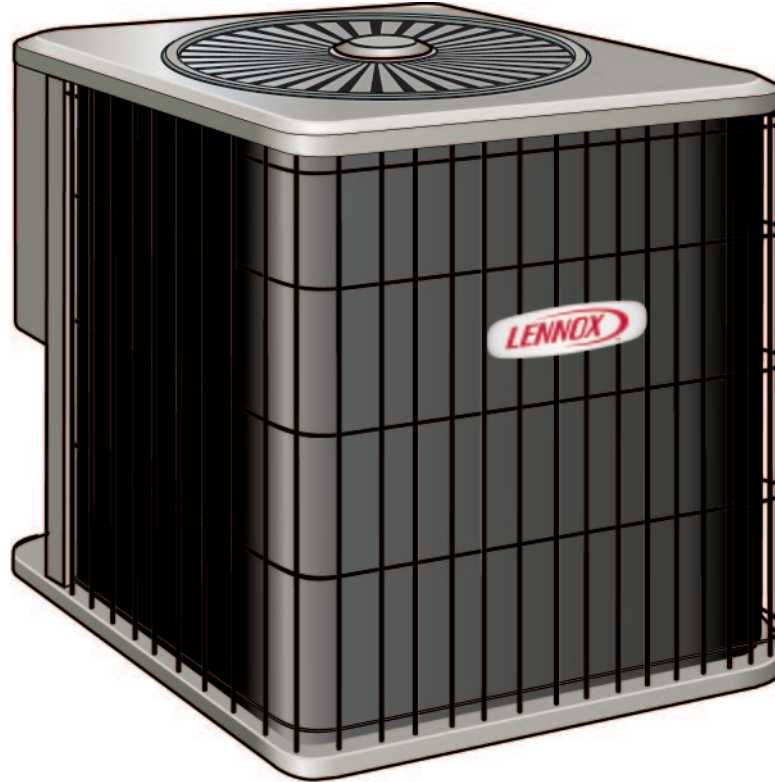

Nominal Capacity - 7 to 17.6 kW (2 to 5 Ton)
Cooling Capacity - 6.4 to 17.6 kW (21 800 to 51 500 Btuh)
Heating Capacity - 6.2 to 14.4 kW (21 000 to 49 000 Btuh)

MODEL NUMBER IDENTIFICATION

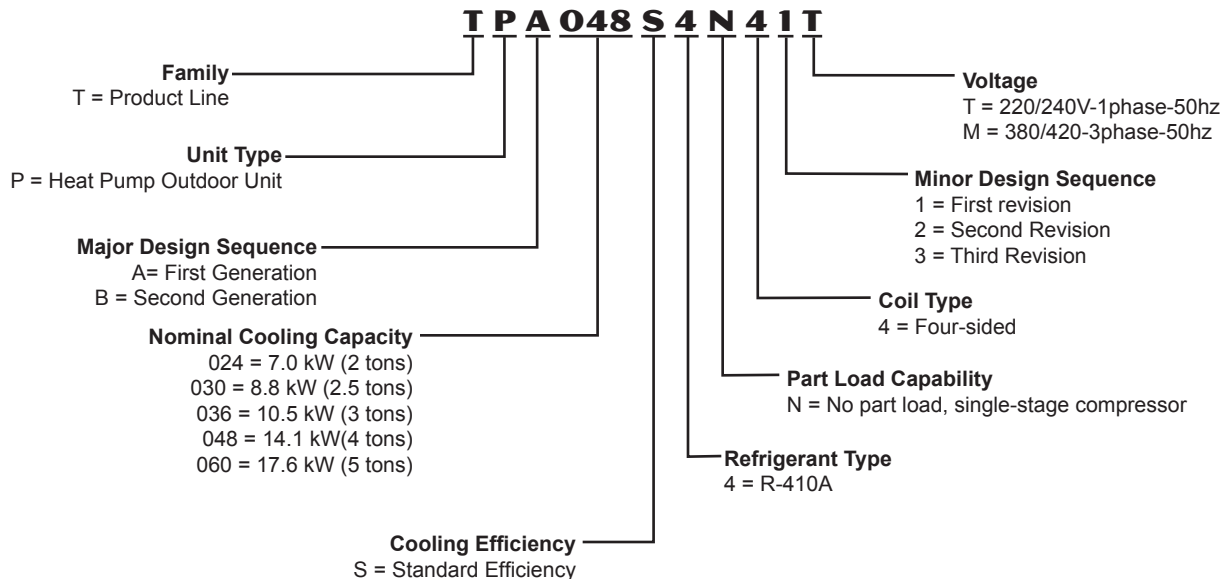

FEATURES AND BENEFITS

CONTENTS

Dimensions	9
Expanded Ratings - Single Phase Models	11
Expanded Ratings - Three Phase Models	17
Features And Benefits	2
Installation Clearances	5
Model Number Identification	1
Optional Temperature Control Systems	8
Ratings.....	10
Sound Data	5
Specifications - Single Phase	6
Specifications - Three Phase.....	7

TESTING

Rated at test conditions included in Air-Conditioning, Heating and Refrigeration Institute (AHRI) Standard 210/240 when operating at rated voltage and air volumes.

Units tested by Intertek for conformity assessment on the conditions set out in the New Approach Directives in support of CE marking. The CE (Conformité Européenne) marking certifies that a product has met EU (European Union) consumer safety, health or environmental requirements.

Units and components within bonded for grounding to meet safety standards for servicing required by Underwriters Laboratories (UL) and the International Electrotechnical Commission (IEC).

International Organization for Standardization (ISO) 9001 Registered Manufacturing Quality System

APPLICATIONS

7 to 17.6 kW.

Single or three phase power supply.

Vertical air discharge allows concealment behind shrubs at grade level or out of sight on a roof.

Designed for applications with remotely located indoor air handler units or gas furnaces (dual-fuel) with indoor add-on coils. See Indoor Coils and Air Handlers sections for indoor unit data.

Units shipped completely factory assembled, piped and wired. Each unit is test operated at the factory insuring proper operation.

Installer must set outdoor unit, connect refrigerant lines and make electrical connections to complete job.

REFRIGERATION SYSTEM

R-410A Refrigerant

Non-chlorine, ozone friendly, R-410A.

Unit pre-charged with refrigerant.

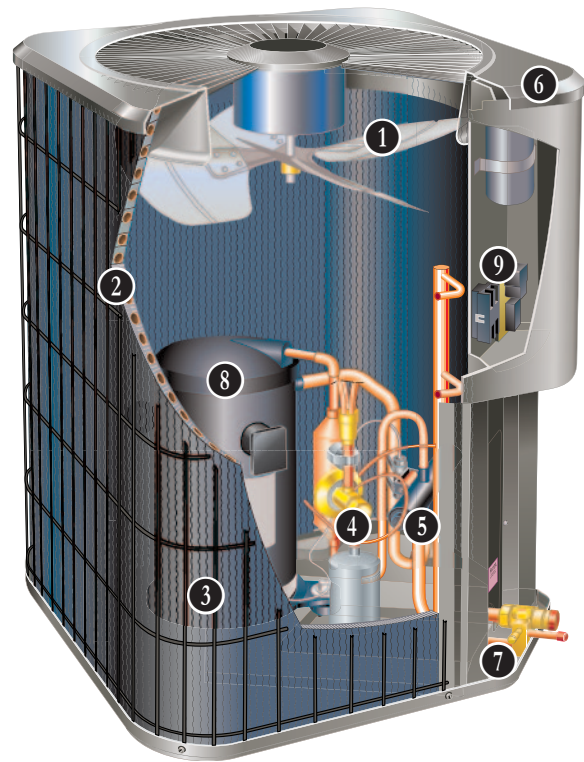

See Specification table.

Unit is factory pre-charged with refrigerant. Total system refrigerant charge is dependant on outdoor unit size, indoor unit size and refrigerant line length.

Refer to Installation Instructions for "Indoor Unit Match-Up and Sub-Cooling Charge Levels" to determine correct amount of charge required.

1 Outdoor Coil Fan

Direct drive fan moves large air volumes uniformly through entire condenser coil for high refrigerant cooling and heating capacity.

Vertical air discharge minimizes operating sounds and eliminates damage to lawn and shrubs.

Louvered steel top fan guard furnished as standard.

Fan service access accomplished by removal of top panel.

FEATURES AND BENEFITS

2 Copper Tube/Enhanced Fin Coil

Lennox designed and fabricated coil.

Ripple-edged aluminum fins.

Copper tube construction.

Lanced fins provide maximum exposure of fin surface to air stream resulting in excellent heat transfer.

Fin collars grip tubing for maximum contact area.

Flared shoulder tubing connections/silver soldering construction.

Coil is factory tested under high pressure to ensure leakproof construction.

Entire coil is accessible for cleaning.

3 Polyvinyl Chloride (PVC) coated steel wire coil guard furnished.

4 Expansion Valve - Outdoor Unit

Designed and sized specifically for use in heat pump system.

Sensing bulb is located on the suction line between the reversing valve and the compressor to sense evaporator suction temperature in any cycle.

Factory installed and piped.

High Pressure Switch

Protects the system from high pressure conditions that can be a result of fan failure or a blocked/dirty coil.

Automatic reset.

Loss of Charge Switch

Helps protect the compressor from damage due low refrigerant charge conditions.

Single-pole, single-throw (SPST), normally-closed switch, automatic reset switch mounted on suction line.

High Capacity Liquid Line Drier

Factory installed in the liquid line, the drier traps moisture or dirt that could contaminate the refrigerant system.

100% molecular-sieve, bead type bi-flow drier.

5 Reversing Valve

4-way interchange reversing valve effects a rapid change in direction of refrigerant flow resulting in quick changeover from cooling to heating and vice versa.

Valve operates on pressure differential between outdoor unit and indoor unit of the system. Factory installed.

OPTIONS

Check/Expansion Valve Kits

Must be ordered extra and field installed on certain indoor units.

Chatleff-style fittings.

Refrigerant Line Kits

Refrigerant lines (suction & liquid) are shipped refrigeration clean. Lines are cleaned, dried, pressurized and sealed at factory.

Suction line fully insulated.

Lines are stubbed at both ends.

Not available for -060 models. Must be field fabricated.

CABINET

6 Heavy gauge steel cabinet with five station metal wash process.

Powder paint finish provides superior rust and corrosion protection.

Painted base section.

Control box is conveniently located with all controls factory wired.

Corner patch plate allows access to compressor components.

Drainage holes are provided in base section for moisture removal.

7 Refrigerant Line Connections, Electrical Inlets, Service Valves

Sweat connection vapor and liquid lines are located on corner of unit cabinet.

Fully serviceable brass service valves prevent corrosion and provide access to refrigerant system. Vapor valve can be fully shut off, while liquid valve may be front seated to manage refrigerant charge while servicing system.

Refrigerant line connections and field wiring inlets are located in one central area of cabinet for easy access. See dimension drawing.

OPTIONS

Hail Guards

Constructed of louvered, heavy-gauge steel painted to match cabinet.

Surrounds unit on all four sides to prevent damage to the coil.

Mounting Base

Provides permanent foundation for outdoor units.

High density polyethylene structural material is lightweight, sturdy, sound absorbing and will withstand the rigors of the sun, heat, cold, moisture, oil and refrigerant. Will not mildew or rot.

Can be shipped singly or in packages of 6 to a carton.

Unit Stand-Off Kit

Black high density polyethylene feet are available to raise unit off of mounting surface away from damaging moisture.

Four feet are furnished per order number.

FEATURES AND BENEFITS

COMPRESSOR

8 Scroll Compressor

Compressor features high efficiency with uniform suction flow, constant discharge flow and high volumetric efficiency and quiet operation.

Compressor consists of two involute spiral scrolls matched together to generate a series of crescent shaped gas pockets between them.

During compression, one scroll remains stationary while the other scroll orbits around it.

Gas is drawn into the outer pocket, the pocket is sealed as the scroll rotates.

As the spiral movement continues, gas pockets are pushed to the center of the scrolls. Volume between the pockets is simultaneously reduced.

When pocket reaches the center, gas is now at high pressure and is forced out of a port located in the center of the fixed scrolls.

During compression, several pockets are compressed simultaneously resulting in a smooth continuous compression cycle.

Continuous flank contact, maintained by centrifugal force, minimizes gas leakage and maximizes efficiency.

Scroll compressor is tolerant to the effects of slugging and contaminants. If this occurs, scrolls separate, allowing liquid or contaminants to be worked toward the center and discharged.

Low gas pulses during compression reduces operational sound levels.

Compressor motor is internally protected from excessive current and temperature.

Muffler in discharge line reduces operating sound levels.

Compressor is installed in the unit on resilient rubber mounts for vibration free operation.

Factory installed crankcase heater protects against refrigerant migration that can occur during low ambient operation.

OPTIONS

Compressor Sound Cover

A reinforced vinyl compressor cover containing a 38 mm thick batt of fiberglass insulation.

All open edges are sealed with a 25 mm wide hook and loop fastening tape.



CONTROLS

9 Defrost Control

Solid-state time/temperature defrost control is furnished as standard equipment.

Control initiates a defrost cycle every 30, 60 or 90 minutes of compressor "on" time at outdoor coil temperatures below 5°C (factory setting 90 minutes).

Anti-short cycle, timed-off control incorporated into the board.

High and low pressure switch monitoring with five-trip lockout.

Diagnostic light emitting diodes (LED's) furnished as an aid in troubleshooting.

Conveniently located in control box.

OPTIONS

Compressor Hard Start Kit

Single-phase units are equipped with a permanent split capacitor (PSC) compressor motor. This type of motor normally doesn't need a potential relay and start capacitor.

In conditions such as low voltage, this kit may be required to increase the compressor starting torque.

Compressor Low Ambient Cut-Off

Non-adjustable switch (low ambient cut-out) prevents compressor operation when outdoor temperature is below 2°C.

Freezestat

Installs on or near the vapor line of the indoor coil or on the suction line.

Senses suction line temperature and cycles the compressor off when suction line temperature falls below its setpoint.

Opens at -2°C and closes at 14°C.

Indoor Blower Off Delay Relay

Delays the indoor blower-off time during the cooling cycle.

See Ratings Table for usage.

Low Ambient Kit

Heat pump in the cooling mode will operate satisfactorily down to 7°C outdoor air temperature without any additional controls.

Low Ambient Control Kit can be field installed, allowing unit operation down to -1°C.

Freezestat should be installed on compressors equipped with a low ambient kit.

A Compressor Low Ambient Cut-Off should be added to terminate compressor operation below recommended operating conditions.

FEATURES AND BENEFITS

CONTROLS (CONTINUED)

OPTIONS

Low Pressure Switch Bypass Thermostat

For use in applications where the heat pump is operated in outdoor ambient temperatures below -9°C.

Prevents nuisance trips from the low pressure switch.

Wired in parallel with the low pressure switch.

Mild Weather Kit

Heat pump units operate satisfactorily in the heating mode at outdoor air temperatures up to 24°C.

Mild Weather Kit can be field installed, allowing heating operation above 24°C.

Monitor Kit - Service Light

Contains ambient compensating thermistor and service light thermostat.

For use with thermostats requiring input for indicator lights.

Outdoor Thermostat Kit

An outdoor thermostat can be used to lock out some of the electric heating elements on indoor units where two stage control is applicable.

Outdoor thermostat maintains the heating load on the low power input as long as possible before allowing the full power load to come on the line.

Thermostat kit and mounting box must be ordered extra.

Thermostat

Thermostat is not furnished with unit and must be ordered extra. See Page 8.

INSTALLATION CLEARANCES - MM (INCHES)

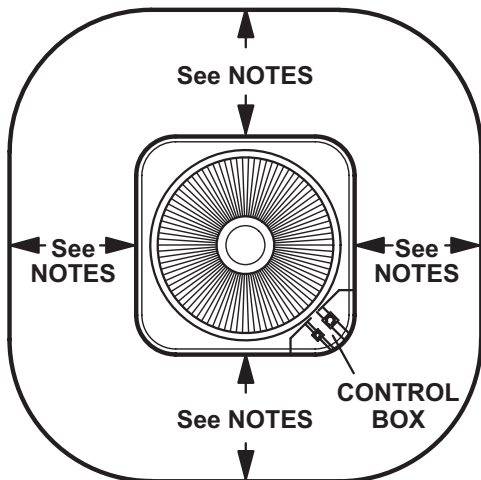

NOTES:

Service clearance of 762 mm (30 in.) must be maintained on one of the sides adjacent to the control box.

Clearance to one of the other three sides must be 914 mm (36 in.)

Clearance to one of the remaining two sides may be 305 mm (12 in.) and the final side may be 152 mm (6 in.).

A clearance of 610 mm (24 in.) must be maintained between two units.

1219 mm (48 in.) clearance required on top of unit.

SOUND DATA

¹ Unit Model No.	Octave Band Sound Power Levels dBA, re 10 ⁻¹² Watts Center Frequency - HZ							¹ Sound Rating Number (dB)
	125	250	500	1000	2000	4000	8000	
220/240V - Single Phase Models								
TPA024S4	51.5	62	64.5	68.5	67	60.5	53.5	76
TPA036S4	52.5	61	67	69	67	61.5	52.5	76
TPA048S4	57.5	67	73	74.5	71	64	58.5	80
380/420V - Three Phase Models								
TPA036S4	70.5	67.5	69.5	72.5	69.5	63	59	76
TPA048S4	73.5	76	76	76.5	72.5	69.5	64.5	80
TPA060S4	73.5	74.5	77	75	72	69	64.5	80

NOTE - the octave sound power data does not include tonal correction.

¹ Tested at conditions included in Air-Conditioning, Heating and Refrigeration Institute (AHRI) Standard 270-95 test.

SPECIFICATIONS - SINGLE PHASE

General Data		Model No.	TPA024S4	TPA036S4	TPA048S4
		Nominal kW	7	10.5	14.0
Connections (sweat)	Liquid line o.d. - in.		3/8	3/8	3/8
	Vapor line o.d. - in.		3/4	7/8	7/8
¹ Refrigerant (R-410A) furnished			2.95 kg (6 lbs. 8 oz.)	2.86 kg (6 lbs. 5 oz.)	5.30 kg (11 lbs. 11 oz.)
Outdoor Coil	Net face area	Outer coil	1.41 (15.21)	1.41 (15.21)	1.96 (21.11)
		Inner coil	- - -	1.44 (15.50)	1.98 (21.31)
	Tube diameter - in.		5/16	5/16	5/16
	Number of rows		1	2	2
	Fins per meter (inch)		866 (22)	866 (22)	866 (22)
Outdoor Fan	Diameter - mm (in.)		457 (18)	457 (18)	559 (22)
	Number of blades		3	4	4
	Motor W (hp)		149 (1/5)	149 (1/5)	248 (1/3)
	L/s (Cfm)		945 (2000)	965 (2042)	1530 (3242)
	Rev / min		942	917	904
	Watts		138	158	313
Shipping Data - kg (lbs.) 1 package			64 (140)	82 (180)	113 (250)
ELECTRICAL DATA					
Line voltage data - 50 hz - 1ph			220 / 240V	220 / 240V	220 / 240V
² Maximum overcurrent protection (amps)			25	35	35
³ Minimum circuit ampacity			14.7	21.1	21.6
Compressor	Rated load amps		10.9	16.0	15.9
	Locked rotor amps		60.0	87.0	98.0
	Power factor		1.1	1.1	1.7
Outdoor Fan Motor	Full load amps		2.0	2.0	4.1
	Locked rotor amps		1.9	1.9	4.1
OPTIONAL ACCESSORIES - MUST BE ORDERED EXTRA					
Compressor Hard Start Kit	10J42				•
	88M91		•	•	
Compressor Low Ambient Cut-Off	45F08		•	•	•
Compressor Sound Cover	69J03		•	•	•
Freezestat	3/8 in. tubing	93G35	•	•	•
	5/8 in. tubing	50A93	•	•	•
Hail Guards	92M88		•	•	
	92M90				•
Indoor Blower Off Delay Relay	58M81		•	•	•
⁴ Low Ambient Kit	54M89		•	•	•
Low Pressure Switch Bypass Thermostat	13W07		•	•	•
Mild Weather Kit	33M07		•	•	•
Monitor Kit - Service Light	76F53		•	•	•
Mounting Base	69J06		•	•	
	69J07		•	•	•
Outdoor Thermostat Kit	Thermostat	56A87	•	•	•
	Mounting Box	31461	•	•	•
Refrigerant Line Sets	L15-41-20, L15-41-30, L15-41-40, L15-41-50		•		
	L15-65-30, L15-65-40, L15-65-50			•	•
	Field Fabricate				
Unit Stand-Off Kit	94J45		•	•	•

NOTE - Extremes of operating range are plus 10% and minus 5% of line voltage.

¹ Refrigerant charge sufficient for 4.6 m (15 ft.) length of refrigerant lines.

² Heating, air conditioning and refrigeration (HACR) type circuit breaker or fuse.

³ Refer to local codes to determine wire, fuse and disconnect size requirements.

⁴ Freezestat is recommended with Low Ambient Kit.

SPECIFICATIONS - THREE PHASE

General Data		Model No.	TPA036S4	TPA048S4	TPA060S4
		Nominal kW	10.5	14.0	17.6
Connections (sweat)	Liquid line o.d. - in.		3/8	3/8	3/8
	Vapor line o.d. - in.		7/8	7/8	1-1/8
¹ Refrigerant (R-410A) furnished			2.86 (6 lbs. 5 oz.)	5.30 (11 lbs. 11 oz.)	6.24 (13 lbs. 12 oz.)
Outdoor Coil	Net face area m ² (sq. ft.)	Outer coil	1.41 (15.21)	1.96 (21.11)	2.28 (24.50)
		Inner coil	1.44 (15.50)	1.98 (21.31)	2.19 (23.56)
	Tube diameter - in.		5/16	5/16	5/16
	Number of rows		2	2	2
	Fins per meter (inch)		866 (22)	866 (22)	866 (22)
Outdoor Fan	Diameter - mm (in.)		457 (18)	559 (22)	559 (22)
	Number of blades		4	4	4
	Motor W (hp)		125 (1/6)	250 (1/3)	185 (1/4)
	L/s (Cfm)		965 (2042)	1530 (3242)	1505 (3192)
	Rev / min		917	904	692
	Watts		158	313	275
Shipping Data - kg (lbs.) 1 package			82 (180)	113 (250)	116 (255)
ELECTRICAL DATA					
Line voltage data - 50 hz - 3ph			380 / 420V	380 / 420V	380 / 420V
² Maximum overcurrent protection (amps)			10	10	15
³ Minimum circuit ampacity			8.0	8.6	10.7
Compressor	Rated load amps		6.0	6.1	7.8
	Locked rotor amps		46.0	43.0	51.5
	Power factor		0.55	1.0	1.0
Outdoor Fan Motor	Full load amps		1.1	2.2	2.3
	Locked rotor amps		1.9	4.1	3.1
OPTIONAL ACCESSORIES - MUST BE ORDERED EXTRA					
Compressor Hard Start Kit	10J42			•	•
	88M91		•		
Compressor Low Ambient Cut-Off	45F08		•	•	•
Compressor Sound Cover	69J03		•	•	•
Freezestat	3/8 in. tubing	93G35	•	•	•
	5/8 in. tubing	50A93	•	•	•
Hail Guards	92M88		•		
	92M90			•	
	92M94				•
Indoor Blower Off Delay Relay	58M81		•	•	•
⁴ Low Ambient Kit	54M89		•	•	•
Low Pressure Switch Bypass Thermostat	13W07		•	•	•
Mild Weather Kit	33M07		•	•	•
Monitor Kit - Service Light	76F53		•	•	•
Mounting Base	69J06		•		
	69J07		•	•	•
Outdoor Thermostat Kit	Thermostat	56A87	•	•	•
	Mounting Box	31461	•	•	•
Refrigerant Line Sets	L15-65-30, L15-65-40, L15-65-50		•	•	
	Field Fabricate				•
Unit Stand-Off Kit	94J45		•	•	•

NOTE - Extremes of operating range are plus 10% and minus 5% of line voltage.

¹ Refrigerant charge sufficient for 4.6 m (15 ft.) length of refrigerant lines.

² Heating, air conditioning and refrigeration (HACR) type circuit breaker or fuse.

³ Refer to local codes to determine wire, fuse and disconnect size requirements.

⁴ Freezestat is recommended with Low Ambient Kit.

OPTIONAL CONVENTIONAL TEMPERATURE CONTROL SYSTEMS - FIELD INSTALLED

COMMERCIAL TOUCHSCREEN THERMOSTAT



Intuitive Touchscreen Interface - **Two Stage Heating / Two Stage Cooling Conventional or Heat Pump** - Seven Day Programmable - Four Time Periods/Day - Economizer Output - Title 24 Compliant - ENERGY STAR® Qualified - Backlit Display - Automatic Changeover

C0STAT02AE1L
(14W81)

Sensors For Touchscreen Thermostat

- ¹ Remote non-adjustable wall mount 20k temperature sensor..... C0SNZN01AE2-
(47W36)
- ¹ Remote non-adjustable wall mount 10k averaging temperature sensor..... C0SNZN73AE1-
(47W37)
- ¹ Remote non-adjustable duct mount temperature sensor..... C0SNDC00AE1-
(19L22)
- Outdoor temperature sensor C0SNSR03AE1-
(X4148)

Accessories For Touchscreen Thermostat

- Locking cover (clear)..... C0MISC15AE1-
(39P21)

¹ Remote sensors for C0STAT02AE1L can be applied in the following combinations: (1) C0SNZN01AE1-, (2) C0SNZN73AE1-, (2) C0SNZN01AE1- and (1) C0SNZN73AE1-, (4) C0SNZN01AE1-, (3) C0SNZN01AE1- and (2) C0SNZN73AE1.

DIGITAL NON-PROGRAMMABLE THERMOSTATS



Intuitive Interface - Automatic Changeover - Simple Up and Down Temperature Control

Two-stage heating / cooling conventional systems..... C0STAT10AE1L
(13K98)

Sensor For Digital Non-Programmable Thermostats Above

Remote wall mounted temperature sensor C0SNZN00AE1-
(26K57)

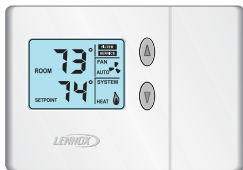

Intuitive Interface - Automatic Changeover - Backlit Display - Simple Up and Down Temperature Control

One-stage heating / cooling conventional systems..... C0STAT12AE1L
(51M32)

Sensor For Digital Non-Programmable Thermostats Above

Outdoor temperature sensor C0SNSR04AE1-
(X2658)

Accessories For Digital Non-Programmable Thermostats Above

Optional wall mounting plate C0MISC17AE1-
(X2659)

DIMENSIONS - MM (INCHES)

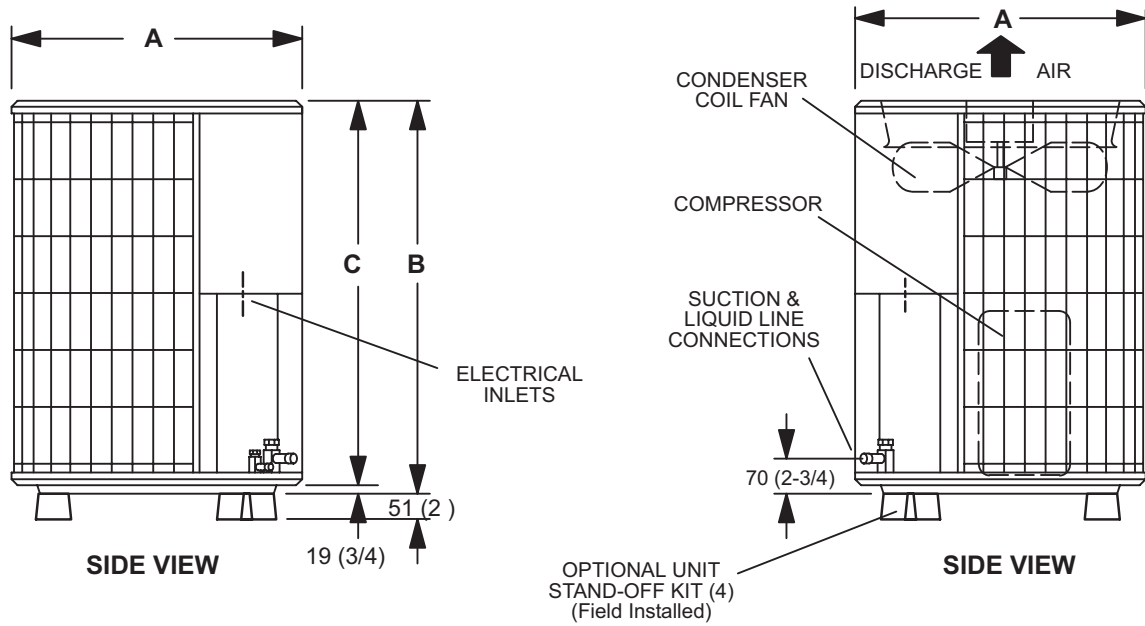
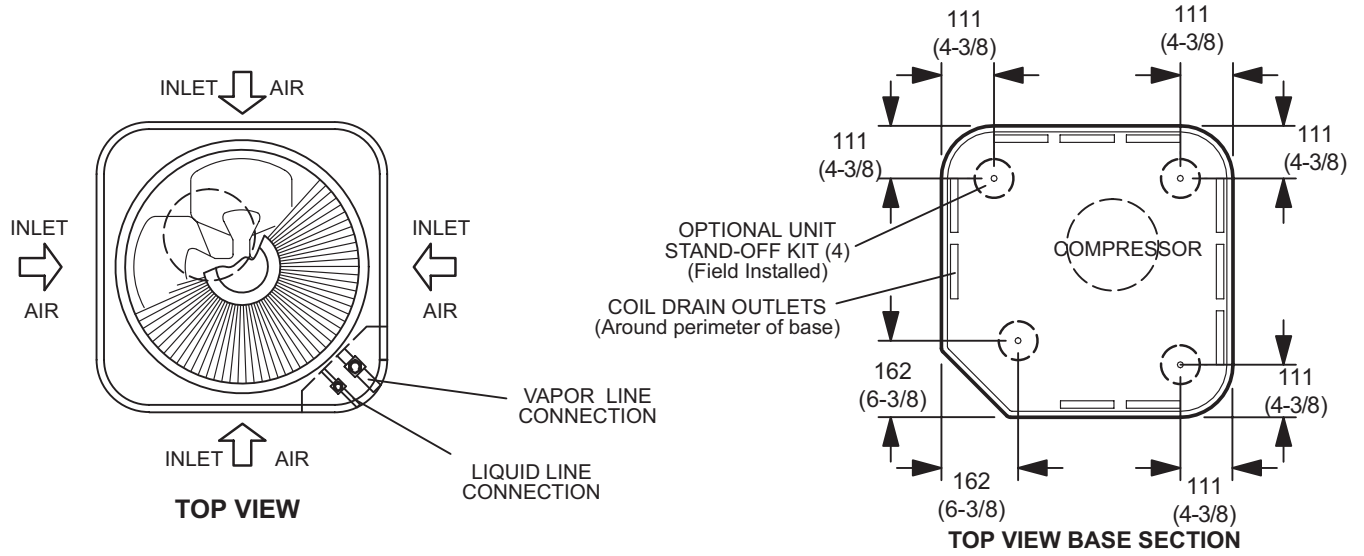

Model No.	A		B		C	
	mm	inches	mm	inches	mm	inches
TPA024S4	616	24-1/4	845	33-1/4	826	32-1/2
TPA036S4						
TPA048S4	718	28-1/4	940	37	921	36-1/4
TPA060S4	718	28-1/4	1099	43-1/4	1080	42-1/2

RATINGS

Outdoor Unit Model Number	1 Net Cooling and Heating Ratings													Indoor Unit Model Number	Expansion Device Required
	Cooling					High Temp. Heating				Low Temp. Heating					
	Capacity		Total Power Input kW	Coefficient of Performance	Energy Efficiency Ratio	Capacity		Total Power Input kW	Coefficient of Performance	Capacity		Total Power Input kW	Coefficient of Performance		
	kW	Btuh				kW	Btuh			kW	Btuh				
SINGLE PHASE															
TPA024S4	6.5	22 200	2.25	2.90	9.90	6.3	21 400	1.97	3.18	3.8	12 900	1800	2.10	BCRMA7924S005	Factory
TPA024S4	6.4	21 800	2.18	2.93	10.00	6.2	21 000	1.95	3.16	3.7	12 500	1760	2.08	CX34-18/24A/B/C	Factory
TPA024S4	6.6	22 400	2.18	3.02	10.30	6.2	21 000	1.93	3.20	3.7	12 500	1760	2.08	CH33-25B-2F	49L24
TPA024S4	6.4	22 000	2.18	2.96	10.10	6.2	21 000	1.94	3.18	3.7	12 500	1775	2.06	CR33-24B-F	49L24
TPA036S4	9.3	31 600	3.43	2.71	9.25	9.7	33 000	2.96	3.26	5.7	19 600	2700	2.12	BCRMB9937S005	Factory
TPA036S4	9.7	33 000	3.23	2.99	10.20	9.4	32 000	2.85	3.30	5.5	18 900	2545	2.18	CX34-38B-6F	Factory
TPA036S4	9.4	32 000	3.22	2.92	9.95	9.4	32 200	2.80	3.38	5.5	18 900	2525	2.20	CH33-36C-2F	49L24
TPA036S4	9.4	32 000	3.22	2.92	9.95	9.4	32 200	2.77	3.40	5.5	18 900	2510	2.20	CR33-30/36B-F	49L24
TPA048S4	11.7	40 000	3.97	2.96	10.10	11.9	40 500	3.52	3.38	7.6	25 800	3335	2.26	BCRMC9960S005	Factory
TPA048S4	11.9	40 500	3.76	3.17	10.80	11.3	38 500	3.59	3.14	7.2	24 400	3350	2.14	CX34-44/48C-6F	Factory
TPA048S4	12.0	41 000	3.76	3.19	10.90	11.4	39 000	3.49	3.28	7.2	24 600	3275	2.20	CH33-48C-2F	91M02
TPA048S4	12.2	41 500	3.76	3.24	11.05	11.6	39 500	3.35	3.46	7.3	24 800	3165	2.30	CR33-50/60C-F	91M02
THREE PHASE															
TPA036S4	9.2	31 400	3.29	2.80	9.55	9.7	33 000	2.89	3.36	6.1	20 800	2670	2.28	BCRMB9937S005	Factory
TPA036S4	9.6	32 600	3.10	3.09	10.55	9.4	32 000	2.76	3.40	5.8	19 900	2520	2.32	CX34-38B-6F	Factory
TPA036S4	9.3	31 800	3.09	3.02	10.30	9.4	32 200	2.72	3.48	5.9	20 000	2500	2.34	CH33-36C-2F	49L24
TPA036S4	9.3	31 800	3.09	3.02	10.30	9.4	32 200	2.70	3.50	5.9	20 000	2490	2.36	CR33-30/36B-F	49L24
TPA048S4	11.6	39 500	3.84	3.02	10.30	11.6	39 500	3.40	3.42	7.3	24 800	3210	2.26	BCRMC9960S005	Factory
TPA048S4	11.7	40 000	3.63	3.22	11.00	11.1	37 800	3.45	3.22	6.9	23 600	3215	2.16	CX34-44/48C-6F	Factory
TPA048S4	12.0	41 000	3.64	3.31	11.30	11.1	38 000	3.36	3.32	6.9	23 600	3145	2.20	CH33-48C-2F	49L24
TPA048S4	12.0	41 000	3.64	3.31	11.30	11.3	38 500	3.22	3.50	7.0	24 000	3040	2.32	CR33-50/60C-F	49L24
TPA060S4	14.4	49 000	4.83	2.97	10.15	14.4	49 000	4.15	3.46	9.0	30 800	3735	2.42	BCRMD1960S005	Factory
TPA060S4	15.1	51 500	4.71	3.21	10.95	14.1	48 000	4.11	3.42	8.8	30 000	3705	2.38	CX34-62D-6F	Factory
TPA060S4	15.1	51 500	4.70	3.21	10.95	13.9	47 500	4.17	3.34	8.7	29 800	3730	2.34	CH33-62D-2F	91M02
TPA060S4	14.5	49 500	4.67	3.11	10.60	14.1	48 000	4.00	3.52	8.9	30 200	3605	2.46	CR33-60D-F	91M02

¹The rating test conditions are those included in Air-Conditioning, Heating and Refrigeration Institute (AHRI) Standard 210/240-94 while operating at rated voltage and air volumes. Cooling Ratings: 35°C (95°F) outdoor air temperature, 26.7°C (80°F) dry bulb and 19.4°C (67°F) wet bulb entering evaporator air with 6.0 m (20 feet) of connecting refrigerant lines.

Net Cooling Capacity = Gross Cooling Capacity - Heat added by indoor blower motor [0.47 m³/s or 3.413 Btu/W (365W per 1000 cfm)] on blower coils

All ratings include the use of a blower time delay relay (TDR). Furnaces and Air Handlers may require an optional time delay relay (**58M81**) for field installation. See furnace or air handler specifications to determine if relay is needed.

EXPANDED RATINGS - SINGLE PHASE MODELS

NOTE – For Temperatures and Capacities not shown in tables, see bulletin – Cooling Unit Rating Table Correction Factor Data in Miscellaneous Engineering Data section.

TPA024S4 Cooling Capacity with

BCRMA7924S005

Entering Wet Bulb Temperature	Total Air Volume	Outdoor Air Temperature Entering Outdoor Coil																							
		27°C						35°C						43°C						52°C					
		Total Cool Cap.	Comp. Motor Input	Sensible To Total Ratio (S/T)			Total Cool Cap.	Comp. Motor Input	Sensible To Total Ratio (S/T)			Total Cool Cap.	Comp. Motor Input	Sensible To Total Ratio (S/T)			Total Cool Cap.	Comp. Motor Input	Sensible To Total Ratio (S/T)						
				Dry Bulb					Dry Bulb					Dry Bulb					Dry Bulb						
L/s	kW	kW	24°C	27°C	29°C	kW	kW	24°C	27°C	29°C	kW	kW	24°C	27°C	29°C	kW	kW	24°C	27°C	29°C					
17°C	315	6.7	1.41	0.73	0.85	0.98	6.2	1.72	0.75	0.89	1.00	5.6	2.11	0.78	0.93	1.00	5.0	2.60	0.83	1.00	1.00				
	390	7.0	1.42	0.77	0.91	1.00	6.5	1.73	0.80	0.96	1.00	5.9	2.12	0.84	1.00	1.00	5.3	2.61	0.90	1.00	1.00				
	470	7.3	1.42	0.81	0.97	1.00	6.8	1.73	0.85	1.00	1.00	6.2	2.12	0.89	1.00	1.00	5.6	2.61	0.97	1.00	1.00				
19°C	315	7.0	1.42	0.58	0.70	0.82	6.5	1.73	0.59	0.73	0.85	6.0	2.12	0.61	0.75	0.90	5.3	2.61	0.64	0.80	0.96				
	390	7.4	1.42	0.60	0.74	0.88	6.9	1.73	0.62	0.77	0.92	6.2	2.12	0.65	0.81	0.97	5.5	2.61	0.68	0.87	1.00				
	470	7.7	1.42	0.63	0.79	0.94	7.1	1.73	0.65	0.82	0.98	6.5	2.12	0.68	0.87	1.00	5.7	2.62	0.72	0.94	1.00				
22°C	315	7.4	1.42	0.45	0.57	0.68	6.9	1.73	0.45	0.58	0.70	6.3	2.12	0.46	0.59	0.73	5.6	2.62	0.47	0.62	0.78				
	390	7.8	1.42	0.45	0.59	0.72	7.3	1.73	0.47	0.61	0.74	6.6	2.12	0.47	0.63	0.78	5.8	2.62	0.49	0.67	0.84				
	470	8.1	1.42	0.47	0.62	0.76	7.5	1.74	0.48	0.64	0.80	6.8	2.13	0.49	0.67	0.84	6.0	2.62	0.51	0.71	0.91				

TPA024S4 Heating Capacity with

BCRMA7924S005

Indoor Coil Air Volume 21°C Dry Bulb	Outdoor Air Temperature Entering Outdoor Coil									
	18°C		7°C		-4°C		-15°C		-26°C	
	Total Cool Cap.	Comp. Motor Input	Total Cool Cap.	Comp. Motor Input	Total Cool Cap.	Comp. Motor Input	Total Cool Cap.	Comp. Motor Input	Total Cool Cap.	Comp. Motor Input
	kW	kW	kW	kW	kW	kW	kW	kW	kW	kW
315	7.6	1.61	5.8	1.51	3.8	1.40	2.6	1.25	1.3	935
390	7.8	1.52	6.0	1.41	4.0	1.31	2.8	1.16	1.5	840
470	8.0	1.46	6.2	1.35	4.2	1.24	3.0	1.10	1.6	780

TPA024S4 Cooling Capacity with

CX34-18/24A/B/C-6F

Entering Wet Bulb Temperature	Total Air Volume	Outdoor Air Temperature Entering Outdoor Coil																							
		27°C						35°C						43°C						52°C					
		Total Cool Cap.	Comp. Motor Input	Sensible To Total Ratio (S/T)			Total Cool Cap.	Comp. Motor Input	Sensible To Total Ratio (S/T)			Total Cool Cap.	Comp. Motor Input	Sensible To Total Ratio (S/T)			Total Cool Cap.	Comp. Motor Input	Sensible To Total Ratio (S/T)						
				Dry Bulb					Dry Bulb					Dry Bulb					Dry Bulb						
L/s	kW	kW	24°C	27°C	29°C	kW	kW	24°C	27°C	29°C	kW	kW	24°C	27°C	29°C	kW	kW	24°C	27°C	29°C					
17°C	330	6.6	1.42	0.75	0.88	0.99	6.2	1.72	0.78	0.91	1.00	5.7	2.12	0.81	0.96	1.00	5.1	2.61	0.87	1.00	1.00				
	380	6.8	1.41	0.77	0.91	1.00	6.3	1.72	0.80	0.95	1.00	5.8	2.12	0.84	0.99	1.00	5.2	2.60	0.91	1.00	1.00				
	425	6.9	1.41	0.80	0.94	1.00	6.5	1.73	0.83	0.98	1.00	6.0	2.12	0.87	1.00	1.00	5.4	2.61	0.95	1.00	1.00				
19°C	330	6.9	1.42	0.61	0.73	0.84	6.5	1.72	0.62	0.75	0.88	6.0	2.11	0.64	0.79	0.93	5.3	2.61	0.68	0.84	0.99				
	380	7.2	1.42	0.62	0.75	0.87	6.7	1.73	0.64	0.78	0.91	6.1	2.11	0.66	0.82	0.97	5.5	2.61	0.70	0.88	1.00				
	425	7.3	1.42	0.63	0.77	0.91	6.8	1.73	0.65	0.80	0.95	6.3	2.11	0.68	0.85	0.99	5.5	2.61	0.72	0.92	1.00				
22°C	330	7.3	1.42	0.48	0.59	0.70	6.8	1.73	0.48	0.61	0.73	6.3	2.11	0.49	0.63	0.76	5.6	2.62	0.50	0.66	0.81				
	380	7.5	1.42	0.48	0.61	0.73	7.0	1.73	0.49	0.62	0.75	6.5	2.12	0.50	0.65	0.79	5.7	2.62	0.52	0.69	0.85				
	425	7.7	1.42	0.49	0.62	0.75	7.2	1.73	0.50	0.64	0.78	6.6	2.12	0.51	0.67	0.82	5.9	2.61	0.53	0.71	0.89				

TPA024S4 Heating Capacity with

CX34-18/24A/B/C-6F

Indoor Coil Air Volume 21°C Dry Bulb	Outdoor Air Temperature Entering Outdoor Coil									
	18°C		7°C		-4°C		-15°C		-26°C	
	Total Cool Cap.	Comp. Motor Input	Total Cool Cap.	Comp. Motor Input	Total Cool Cap.	Comp. Motor Input	Total Cool Cap.	Comp. Motor Input	Total Cool Cap.	Comp. Motor Input
	kW	kW	kW	kW	kW	kW	kW	kW	kW	kW
330	7.5	1.64	5.7	1.52	3.8	1.39	2.6	1.23	1.3	910
380	7.6	1.60	5.8	1.47	3.9	1.34	2.8	1.18	1.4	860
425	7.7	1.56	5.9	1.43	4.0	1.31	2.8	1.14	1.5	825

EXPANDED RATINGS - SINGLE PHASE MODELS

NOTE – For Temperatures and Capacities not shown in tables, see bulletin – Cooling Unit Rating Table Correction Factor Data in Miscellaneous Engineering Data section.

TPA024S4 Cooling Capacity with

CH33-25A-2F

Entering Wet Bulb Temperature	Total Air Volume	Outdoor Air Temperature Entering Outdoor Coil																							
		27°C						35°C						43°C						52°C					
		Total Cool Cap.	Comp. Motor Input	Sensible To Total Ratio (S/T)			Total Cool Cap.	Comp. Motor Input	Sensible To Total Ratio (S/T)			Total Cool Cap.	Comp. Motor Input	Sensible To Total Ratio (S/T)			Total Cool Cap.	Comp. Motor Input	Sensible To Total Ratio (S/T)						
				Dry Bulb					Dry Bulb					Dry Bulb					Dry Bulb						
L/s	kW	kW	24°C	27°C	29°C	kW	kW	24°C	27°C	29°C	kW	kW	24°C	27°C	29°C	kW	kW	24°C	27°C	29°C					
17°C	330	7.0	1.42	0.76	0.90	1.00	6.5	1.73	0.79	0.94	1.00	5.9	2.12	0.83	0.99	1.00	5.2	2.61	0.89	1.00	1.00				
	380	7.2	1.42	0.79	0.94	1.00	6.7	1.73	0.82	0.98	1.00	6.1	2.12	0.86	1.00	1.00	5.5	2.61	0.93	1.00	1.00				
	425	7.4	1.42	0.82	0.98	1.00	6.9	1.73	0.86	1.00	1.00	6.3	2.12	0.90	1.00	1.00	5.7	2.62	0.98	1.00	1.00				
19°C	330	7.4	1.42	0.60	0.73	0.86	6.9	1.73	0.63	0.76	0.90	6.3	2.12	0.64	0.80	0.95	5.5	2.61	0.68	0.86	1.00				
	380	7.6	1.42	0.63	0.77	0.90	7.1	1.73	0.64	0.80	0.94	6.4	2.12	0.67	0.84	0.99	5.7	2.62	0.71	0.90	1.00				
	425	7.8	1.42	0.64	0.80	0.94	7.2	1.73	0.66	0.83	0.98	6.6	2.12	0.69	0.88	1.00	5.7	2.62	0.74	0.95	1.00				
22°C	330	7.9	1.42	0.46	0.59	0.71	7.3	1.73	0.47	0.61	0.74	6.7	2.12	0.48	0.63	0.77	5.9	2.62	0.50	0.66	0.83				
	380	8.1	1.42	0.47	0.61	0.74	7.5	1.74	0.49	0.63	0.77	6.9	2.13	0.50	0.66	0.81	6.0	2.62	0.51	0.69	0.87				
	425	8.2	1.42	0.49	0.63	0.77	7.6	1.74	0.50	0.65	0.80	7.0	2.13	0.51	0.68	0.85	6.1	2.63	0.53	0.73	0.92				

TPA024S4 Heating Capacity with

CH33-25A-2F

Indoor Coil Air Volume 21°C Dry Bulb	Outdoor Air Temperature Entering Outdoor Coil									
	18°C		7°C		-4°C		-15°C		-26°C	
	Total Cool Cap.	Comp. Motor Input	Total Cool Cap.	Comp. Motor Input	Total Cool Cap.	Comp. Motor Input	Total Cool Cap.	Comp. Motor Input	Total Cool Cap.	Comp. Motor Input
kW	kW	kW	kW	kW	kW	kW	kW	kW	kW	kW
330	7.7	1.55	5.8	1.45	3.9	1.35	2.7	1.21	1.3	890
380	7.8	1.51	5.9	1.41	4.0	1.31	2.8	1.17	1.4	845
425	7.9	1.47	6.0	1.37	4.1	1.26	2.9	1.13	1.5	805

TPA024S4 Cooling Capacity with

CR33-24B-F

Entering Wet Bulb Temperature	Total Air Volume	Outdoor Air Temperature Entering Outdoor Coil																							
		27°C						35°C						43°C						52°C					
		Total Cool Cap.	Comp. Motor Input	Sensible To Total Ratio (S/T)			Total Cool Cap.	Comp. Motor Input	Sensible To Total Ratio (S/T)			Total Cool Cap.	Comp. Motor Input	Sensible To Total Ratio (S/T)			Total Cool Cap.	Comp. Motor Input	Sensible To Total Ratio (S/T)						
				Dry Bulb					Dry Bulb					Dry Bulb					Dry Bulb						
L/s	kW	kW	24°C	27°C	29°C	kW	kW	24°C	27°C	29°C	kW	kW	24°C	27°C	29°C	kW	kW	24°C	27°C	29°C					
17°C	330	7.0	1.42	0.76	0.90	1.00	6.5	1.73	0.79	0.94	1.00	5.9	2.12	0.83	0.99	1.00	5.2	2.61	0.89	1.00	1.00				
	380	7.2	1.42	0.79	0.94	1.00	6.7	1.73	0.82	0.98	1.00	6.1	2.12	0.86	1.00	1.00	5.5	2.61	0.93	1.00	1.00				
	425	7.4	1.42	0.82	0.98	1.00	6.9	1.73	0.86	1.00	1.00	6.3	2.12	0.90	1.00	1.00	5.7	2.62	0.98	1.00	1.00				
19°C	330	7.4	1.42	0.60	0.73	0.86	6.9	1.73	0.63	0.76	0.90	6.3	2.12	0.64	0.80	0.95	5.5	2.61	0.68	0.86	1.00				
	380	7.6	1.42	0.63	0.77	0.90	7.1	1.73	0.64	0.80	0.94	6.4	2.12	0.67	0.84	0.99	5.7	2.62	0.71	0.90	1.00				
	425	7.8	1.42	0.64	0.80	0.94	7.2	1.73	0.66	0.83	0.98	6.6	2.12	0.69	0.88	1.00	5.7	2.62	0.74	0.95	1.00				
22°C	330	7.9	1.42	0.46	0.59	0.71	7.3	1.73	0.47	0.61	0.74	6.7	2.12	0.48	0.63	0.77	5.9	2.62	0.50	0.66	0.83				
	380	8.1	1.42	0.47	0.61	0.74	7.5	1.74	0.49	0.63	0.77	6.9	2.13	0.50	0.66	0.81	6.0	2.62	0.51	0.69	0.87				
	425	8.2	1.42	0.49	0.63	0.77	7.6	1.74	0.50	0.65	0.80	7.0	2.13	0.51	0.68	0.85	6.1	2.63	0.53	0.73	0.92				

TPA024S4 Heating Capacity with

CR33-24B-F

Indoor Coil Air Volume 21°C Dry Bulb	Outdoor Air Temperature Entering Outdoor Coil									
	18°C		7°C		-4°C		-15°C		-26°C	
	Total Cool Cap.	Comp. Motor Input	Total Cool Cap.	Comp. Motor Input	Total Cool Cap.	Comp. Motor Input	Total Cool Cap.	Comp. Motor Input	Total Cool Cap.	Comp. Motor Input
kW	kW	kW	kW	kW	kW	kW	kW	kW	kW	kW
330	7.5	1.66	5.7	1.53	3.8	1.40	2.6	1.24	1.3	915
380	7.6	1.61	5.8	1.48	3.9	1.35	2.8	1.19	1.4	865
425	7.7	1.57	5.9	1.44	4.0	1.31	2.8	1.15	1.5	825

EXPANDED RATINGS - SINGLE PHASE MODELS

NOTE – For Temperatures and Capacities not shown in tables, see bulletin – Cooling Unit Rating Table Correction Factor Data in Miscellaneous Engineering Data section.

TPA036S4 Cooling Capacity with

BCRMB9937S005

Entering Wet Bulb Temperature	Total Air Volume	Outdoor Air Temperature Entering Outdoor Coil																							
		27°C						35°C						43°C						52°C					
		Total Cool Cap.	Comp. Motor Input	Sensible To Total Ratio (S/T)			Total Cool Cap.	Comp. Motor Input	Sensible To Total Ratio (S/T)			Total Cool Cap.	Comp. Motor Input	Sensible To Total Ratio (S/T)			Total Cool Cap.	Comp. Motor Input	Sensible To Total Ratio (S/T)						
				Dry Bulb					Dry Bulb					Dry Bulb					Dry Bulb						
L/s	kW	kW	24°C	27°C	29°C	kW	kW	24°C	27°C	29°C	kW	kW	24°C	27°C	29°C	kW	kW	24°C	27°C	29°C					
17°C	455	9.6	2.12	0.74	0.87	0.99	8.9	2.59	0.76	0.91	1.00	8.1	3.15	0.80	0.96	1.00	7.1	3.85	0.85	1.00	1.00				
	570	10.1	2.14	0.78	0.93	1.00	9.3	2.60	0.82	0.98	1.00	8.5	3.17	0.86	1.00	1.00	7.6	3.87	0.93	1.00	1.00				
	685	10.5	2.15	0.83	0.99	1.00	9.7	2.62	0.87	1.00	1.00	8.9	3.19	0.92	1.00	1.00	7.9	3.89	0.99	1.00	1.00				
19°C	455	10.3	2.15	0.59	0.71	0.84	9.5	2.61	0.60	0.74	0.87	8.6	3.17	0.62	0.77	0.92	7.6	3.87	0.65	0.83	0.99				
	570	10.8	2.17	0.62	0.76	0.90	9.9	2.63	0.63	0.79	0.94	8.9	3.19	0.66	0.84	0.99	7.8	3.89	0.70	0.90	1.00				
	685	11.1	2.18	0.64	0.80	0.96	10.2	2.64	0.66	0.84	1.00	9.2	3.20	0.70	0.90	1.00	8.0	3.89	0.74	0.97	1.00				
22°C	455	10.8	2.17	0.45	0.57	0.69	10.1	2.63	0.45	0.59	0.71	9.1	3.20	0.46	0.61	0.75	8.0	3.90	0.47	0.64	0.80				
	570	11.3	2.19	0.46	0.60	0.74	10.5	2.65	0.46	0.62	0.77	9.5	3.21	0.48	0.65	0.81	8.4	3.92	0.49	0.69	0.88				
	685	11.7	2.21	0.47	0.63	0.78	10.8	2.66	0.48	0.65	0.82	9.7	3.23	0.49	0.69	0.87	8.5	3.92	0.52	0.74	0.94				

TPA036S4 Heating Capacity with

BCRMB9937S005

Indoor Coil Air Volume 21°C Dry Bulb	Outdoor Air Temperature Entering Outdoor Coil									
	18°C		7°C		-4°C		-15°C		-26°C	
	Total Cool Cap.	Comp. Motor Input	Total Cool Cap.	Comp. Motor Input	Total Cool Cap.	Comp. Motor Input	Total Cool Cap.	Comp. Motor Input	Total Cool Cap.	Comp. Motor Input
	kW	kW	kW	kW	kW	kW	kW	kW	kW	kW
455	11.7	2.46	8.9	2.27	5.8	2.08	4.0	1.86	2.0	1.40
570	12.0	2.31	9.1	2.12	6.1	1.93	4.3	1.71	2.3	1.25
685	12.2	2.21	9.4	2.02	6.3	1.83	4.5	1.62	2.5	1.15

TPA036S4 Cooling Capacity with

CX34-38B-6F

Entering Wet Bulb Temperature	Total Air Volume	Outdoor Air Temperature Entering Outdoor Coil																							
		27°C						35°C						43°C						52°C					
		Total Cool Cap.	Comp. Motor Input	Sensible To Total Ratio (S/T)			Total Cool Cap.	Comp. Motor Input	Sensible To Total Ratio (S/T)			Total Cool Cap.	Comp. Motor Input	Sensible To Total Ratio (S/T)			Total Cool Cap.	Comp. Motor Input	Sensible To Total Ratio (S/T)						
				Dry Bulb					Dry Bulb					Dry Bulb					Dry Bulb						
L/s	kW	kW	24°C	27°C	29°C	kW	kW	24°C	27°C	29°C	kW	kW	24°C	27°C	29°C	kW	kW	24°C	27°C	29°C					
17°C	470	10.0	2.14	0.77	0.90	1.00	9.1	2.59	0.79	0.95	1.00	8.3	3.16	0.83	0.99	1.00	7.4	3.86	0.89	1.00	1.00				
	565	10.3	2.15	0.81	0.96	1.00	9.5	2.61	0.84	1.00	1.00	8.7	3.17	0.89	1.00	1.00	7.8	3.88	0.96	1.00	1.00				
	660	10.7	2.16	0.85	1.00	1.00	9.9	2.63	0.89	1.00	1.00	9.1	3.19	0.94	1.00	1.00	8.1	3.90	1.00	1.00	1.00				
19°C	470	10.6	2.16	0.61	0.74	0.87	9.8	2.62	0.63	0.77	0.91	8.8	3.18	0.65	0.81	0.96	7.7	3.88	0.69	0.87	1.00				
	565	11.0	2.18	0.63	0.78	0.93	10.1	2.63	0.66	0.82	0.97	9.1	3.19	0.68	0.86	1.00	7.9	3.89	0.73	0.93	1.00				
	660	11.3	2.19	0.66	0.83	0.98	10.3	2.64	0.69	0.87	1.00	9.3	3.21	0.72	0.92	1.00	8.1	3.90	0.77	0.99	1.00				
22°C	470	11.1	2.18	0.47	0.59	0.72	10.3	2.64	0.48	0.61	0.75	9.3	3.21	0.49	0.64	0.79	8.2	3.91	0.51	0.68	0.84				
	565	11.5	2.20	0.48	0.62	0.76	10.6	2.66	0.49	0.64	0.79	9.6	3.22	0.50	0.67	0.84	8.4	3.92	0.52	0.72	0.91				
	660	11.9	2.21	0.50	0.65	0.80	10.9	2.67	0.51	0.68	0.85	9.8	3.23	0.52	0.71	0.90	8.6	3.93	0.55	0.77	0.97				

TPA036S4 Heating Capacity with

CX34-38B-6F

Indoor Coil Air Volume 21°C Dry Bulb	Outdoor Air Temperature Entering Outdoor Coil									
	18°C		7°C		-4°C		-15°C		-26°C	
	Total Cool Cap.	Comp. Motor Input	Total Cool Cap.	Comp. Motor Input	Total Cool Cap.	Comp. Motor Input	Total Cool Cap.	Comp. Motor Input	Total Cool Cap.	Comp. Motor Input
	kW	kW	kW	kW	kW	kW	kW	kW	kW	kW
470	11.5	2.55	8.7	2.33	5.7	2.11	4.0	1.89	2.0	1.42
565	11.7	2.42	8.9	2.20	5.9	1.98	4.1	1.75	2.2	1.28
660	11.9	2.32	9.1	2.11	6.1	1.88	4.4	1.66	2.4	1.19

EXPANDED RATINGS - SINGLE PHASE MODELS

NOTE – For Temperatures and Capacities not shown in tables, see bulletin – Cooling Unit Rating Table Correction Factor Data in Miscellaneous Engineering Data section.

TPA036S4 Cooling Capacity with

CH33-36C-2F

Entering Wet Bulb Temperature	Total Air Volume	Outdoor Air Temperature Entering Outdoor Coil																							
		27°C						35°C						43°C						52°C					
		Total Cool Cap.	Comp. Motor Input	Sensible To Total Ratio (S/T)			Total Cool Cap.	Comp. Motor Input	Sensible To Total Ratio (S/T)			Total Cool Cap.	Comp. Motor Input	Sensible To Total Ratio (S/T)			Total Cool Cap.	Comp. Motor Input	Sensible To Total Ratio (S/T)						
				Dry Bulb					Dry Bulb					Dry Bulb					Dry Bulb						
L/s	kW	kW	24°C	27°C	29°C	kW	kW	24°C	27°C	29°C	kW	kW	24°C	27°C	29°C	kW	kW	24°C	27°C	29°C					
17°C	470	9.8	2.13	0.77	0.91	1.00	9.0	2.59	0.80	0.95	1.00	8.1	3.15	0.84	1.00	1.00	7.3	3.86	0.90	1.00	1.00				
	565	10.1	2.14	0.81	0.97	1.00	9.3	2.60	0.85	1.00	1.00	8.5	3.17	0.89	1.00	1.00	7.6	3.88	0.96	1.00	1.00				
	660	10.5	2.16	0.86	1.00	1.00	9.7	2.62	0.90	1.00	1.00	8.9	3.19	0.95	1.00	1.00	7.9	3.89	1.00	1.00	1.00				
19°C	470	10.3	2.15	0.62	0.75	0.88	9.5	2.61	0.64	0.78	0.92	8.6	3.17	0.66	0.82	0.97	7.5	3.87	0.70	0.88	1.00				
	565	10.7	2.16	0.64	0.79	0.93	9.8	2.62	0.66	0.82	0.98	8.9	3.19	0.69	0.87	1.00	7.8	3.88	0.73	0.94	1.00				
	660	11.0	2.18	0.67	0.83	0.99	10.1	2.63	0.69	0.87	1.00	9.1	3.20	0.73	0.93	1.00	8.0	3.89	0.78	1.00	1.00				
22°C	470	10.7	2.17	0.48	0.60	0.73	9.9	2.63	0.48	0.62	0.75	9.0	3.19	0.49	0.65	0.79	7.9	3.89	0.51	0.69	0.85				
	565	11.1	2.18	0.48	0.63	0.77	10.3	2.64	0.49	0.65	0.80	9.3	3.21	0.51	0.68	0.85	8.2	3.91	0.53	0.72	0.92				
	660	11.5	2.20	0.50	0.66	0.81	10.6	2.66	0.51	0.68	0.85	9.6	3.22	0.53	0.72	0.90	8.4	3.92	0.55	0.77	0.98				

TPA036S4 Heating Capacity with

CH33-36C-2F

Indoor Coil Air Volume 21°C Dry Bulb	Outdoor Air Temperature Entering Outdoor Coil									
	18°C		7°C		-4°C		-15°C		-26°C	
	Total Cool Cap.	Comp. Motor Input	Total Cool Cap.	Comp. Motor Input	Total Cool Cap.	Comp. Motor Input	Total Cool Cap.	Comp. Motor Input	Total Cool Cap.	Comp. Motor Input
kW	kW	kW	kW	kW	kW	kW	kW	kW	kW	kW
470	11.6	2.49	8.8	2.29	5.8	2.08	4.0	1.86	2.0	1.40
565	11.7	2.36	8.9	2.16	5.9	1.95	4.1	1.73	2.2	1.27
660	12.0	2.27	9.1	2.08	6.1	1.87	4.4	1.65	2.4	1.18

TPA036S4 Cooling Capacity with

CR33-30/36B-F

Entering Wet Bulb Temperature	Total Air Volume	Outdoor Air Temperature Entering Outdoor Coil																							
		27°C						35°C						43°C						52°C					
		Total Cool Cap.	Comp. Motor Input	Sensible To Total Ratio (S/T)			Total Cool Cap.	Comp. Motor Input	Sensible To Total Ratio (S/T)			Total Cool Cap.	Comp. Motor Input	Sensible To Total Ratio (S/T)			Total Cool Cap.	Comp. Motor Input	Sensible To Total Ratio (S/T)						
				Dry Bulb					Dry Bulb					Dry Bulb					Dry Bulb						
L/s	kW	kW	24°C	27°C	29°C	kW	kW	24°C	27°C	29°C	kW	kW	24°C	27°C	29°C	kW	kW	24°C	27°C	29°C					
17°C	470	9.8	2.13	0.77	0.91	1.00	9.0	2.59	0.80	0.95	1.00	8.1	3.15	0.84	0.99	1.00	7.2	3.85	0.90	1.00	1.00				
	565	10.1	2.14	0.81	0.96	1.00	9.3	2.60	0.84	0.99	1.00	8.5	3.17	0.89	1.00	1.00	7.6	3.87	0.95	1.00	1.00				
	660	10.4	2.15	0.85	1.00	1.00	9.7	2.62	0.89	1.00	1.00	8.9	3.18	0.95	1.00	1.00	7.9	3.89	1.00	1.00	1.00				
19°C	470	10.3	2.15	0.61	0.74	0.88	9.5	2.61	0.63	0.77	0.91	8.6	3.17	0.66	0.81	0.96	7.6	3.87	0.69	0.87	1.00				
	565	10.7	2.16	0.64	0.79	0.93	9.8	2.62	0.66	0.82	0.97	8.9	3.19	0.69	0.87	1.00	7.8	3.88	0.73	0.93	1.00				
	660	10.9	2.17	0.67	0.83	0.98	10.1	2.63	0.69	0.87	1.00	9.1	3.19	0.73	0.92	1.00	8.0	3.89	0.78	0.98	1.00				
22°C	470	10.9	2.17	0.47	0.60	0.72	10.1	2.63	0.48	0.62	0.75	9.1	3.19	0.49	0.64	0.79	8.0	3.90	0.51	0.68	0.85				
	565	11.3	2.19	0.48	0.62	0.76	10.3	2.64	0.49	0.64	0.80	9.4	3.21	0.50	0.68	0.84	8.2	3.91	0.52	0.72	0.91				
	660	11.5	2.20	0.50	0.66	0.81	10.6	2.66	0.51	0.68	0.85	9.6	3.22	0.53	0.72	0.90	8.4	3.92	0.55	0.77	0.97				

TPA036S4 Heating Capacity with

CR33-30/36B-F

Indoor Coil Air Volume 21°C Dry Bulb	Outdoor Air Temperature Entering Outdoor Coil									
	18°C		7°C		-4°C		-15°C		-26°C	
	Total Cool Cap.	Comp. Motor Input	Total Cool Cap.	Comp. Motor Input	Total Cool Cap.	Comp. Motor Input	Total Cool Cap.	Comp. Motor Input	Total Cool Cap.	Comp. Motor Input
kW	kW	kW	kW	kW	kW	kW	kW	kW	kW	kW
470	11.6	2.45	8.8	2.26	5.8	2.07	4.0	1.85	2.0	1.39
565	11.8	2.32	8.9	2.14	5.9	1.95	4.1	1.73	2.2	1.26
660	12.0	2.24	9.1	2.10	6.1	1.86	4.4	1.65	2.4	1.18

EXPANDED RATINGS - SINGLE PHASE MODELS

NOTE – For Temperatures and Capacities not shown in tables, see bulletin – Cooling Unit Rating Table Correction Factor Data in Miscellaneous Engineering Data section.

TPA048S4 Cooling Capacity with

BCRMC9960S005

Entering Wet Bulb Temperature	Total Air Volume	Outdoor Air Temperature Entering Outdoor Coil																							
		27°C						35°C						43°C						52°C					
		Total Cool Cap.	Comp. Motor Input	Sensible To Total Ratio (S/T)			Total Cool Cap.	Comp. Motor Input	Sensible To Total Ratio (S/T)			Total Cool Cap.	Comp. Motor Input	Sensible To Total Ratio (S/T)			Total Cool Cap.	Comp. Motor Input	Sensible To Total Ratio (S/T)						
				Dry Bulb					Dry Bulb					Dry Bulb					Dry Bulb						
L/s	kW	kW	24°C	27°C	29°C	kW	kW	24°C	27°C	29°C	kW	kW	24°C	27°C	29°C	kW	kW	24°C	27°C	29°C					
17°C	575	12.1	2.36	0.75	0.88	1.00	11.3	2.86	0.77	0.92	1.00	10.3	3.48	0.80	0.96	1.00	9.2	4.30	0.85	1.00	1.00				
	715	12.7	2.37	0.79	0.95	1.00	11.8	2.86	0.83	0.99	1.00	10.9	3.49	0.87	1.00	1.00	9.8	4.30	0.92	1.00	1.00				
	860	13.2	2.38	0.84	1.00	1.00	12.3	2.86	0.88	1.00	1.00	11.4	3.49	0.93	1.00	1.00	10.4	4.29	0.99	1.00	1.00				
19°C	575	12.9	2.37	0.59	0.72	0.85	12.0	2.86	0.61	0.75	0.88	11.0	3.48	0.62	0.78	0.93	9.8	4.30	0.65	0.82	0.98				
	715	13.5	2.38	0.62	0.77	0.92	12.5	2.87	0.64	0.80	0.96	11.5	3.49	0.66	0.84	1.00	10.2	4.29	0.70	0.90	1.00				
	860	13.9	2.39	0.65	0.82	0.98	12.9	2.87	0.67	0.86	1.00	11.8	3.49	0.70	0.91	1.00	10.5	4.28	0.74	0.97	1.00				
22°C	575	13.6	2.38	0.45	0.58	0.70	12.7	2.87	0.45	0.59	0.72	11.7	3.49	0.46	0.61	0.75	10.4	4.29	0.47	0.64	0.80				
	715	14.2	2.39	0.46	0.61	0.75	13.2	2.88	0.47	0.63	0.78	12.2	3.49	0.48	0.65	0.82	10.8	4.28	0.49	0.69	0.87				
	860	14.7	2.40	0.48	0.64	0.80	13.6	2.88	0.48	0.66	0.83	12.5	3.49	0.50	0.69	0.88	11.1	4.28	0.51	0.74	0.95				

TPA048S4 Heating Capacity with

BCRMC9960S005

Indoor Coil Air Volume 21°C Dry Bulb	Outdoor Air Temperature Entering Outdoor Coil									
	18°C		7°C		-4°C		-15°C		-26°C	
	Total Cool Cap.	Comp. Motor Input	Total Cool Cap.	Comp. Motor Input	Total Cool Cap.	Comp. Motor Input	Total Cool Cap.	Comp. Motor Input	Total Cool Cap.	Comp. Motor Input
	kW	kW	kW	kW	kW	kW	kW	kW	kW	kW
575	14.0	2.67	10.9	2.54	7.6	2.42	5.5	2.20	2.6	1.63
715	14.4	2.51	11.3	2.39	8.0	2.26	5.8	2.04	3.0	1.48
860	14.7	2.41	11.6	2.29	8.3	2.16	6.1	1.94	3.3	1.38

TPA048S4 Cooling Capacity with

CX34-44/48C-6F

Entering Wet Bulb Temperature	Total Air Volume	Outdoor Air Temperature Entering Outdoor Coil																							
		27°C						35°C						43°C						52°C					
		Total Cool Cap.	Comp. Motor Input	Sensible To Total Ratio (S/T)			Total Cool Cap.	Comp. Motor Input	Sensible To Total Ratio (S/T)			Total Cool Cap.	Comp. Motor Input	Sensible To Total Ratio (S/T)			Total Cool Cap.	Comp. Motor Input	Sensible To Total Ratio (S/T)						
				Dry Bulb					Dry Bulb					Dry Bulb					Dry Bulb						
L/s	kW	kW	24°C	27°C	29°C	kW	kW	24°C	27°C	29°C	kW	kW	24°C	27°C	29°C	kW	kW	24°C	27°C	29°C					
17°C	660	12.4	2.37	0.78	0.92	1.00	11.5	2.85	0.80	0.95	1.00	10.6	3.48	0.84	0.99	1.00	9.5	4.28	0.89	1.00	1.00				
	755	12.7	2.37	0.81	0.96	1.00	11.8	2.86	0.84	0.99	1.00	10.9	3.48	0.88	1.00	1.00	9.9	4.30	0.93	1.00	1.00				
	850	13.0	2.37	0.84	0.99	1.00	12.1	2.86	0.87	1.00	1.00	11.2	3.48	0.91	1.00	1.00	10.1	4.29	0.97	1.00	1.00				
19°C	660	13.1	2.38	0.61	0.75	0.88	12.2	2.86	0.63	0.78	0.92	11.2	3.48	0.65	0.81	0.96	10.0	4.30	0.68	0.86	1.00				
	755	13.4	2.38	0.64	0.78	0.93	12.5	2.87	0.65	0.81	0.96	11.4	3.49	0.68	0.85	1.00	10.2	4.29	0.71	0.91	1.00				
	850	13.7	2.39	0.66	0.81	0.96	12.7	2.87	0.67	0.85	1.00	11.6	3.49	0.70	0.89	1.00	10.3	4.29	0.74	0.95	1.00				
22°C	660	13.8	2.39	0.47	0.60	0.73	12.9	2.87	0.48	0.62	0.75	11.8	3.49	0.49	0.64	0.79	10.6	4.28	0.50	0.67	0.84				
	755	14.2	2.39	0.48	0.62	0.76	13.2	2.87	0.49	0.64	0.79	12.1	3.49	0.50	0.67	0.83	10.8	4.29	0.52	0.70	0.88				
	850	14.4	2.40	0.49	0.64	0.79	13.5	2.88	0.50	0.66	0.82	12.3	3.49	0.51	0.69	0.87	11.0	4.29	0.53	0.73	0.93				

TPA048S4 Heating Capacity with

CX34-44/48C-6F

Indoor Coil Air Volume 21°C Dry Bulb	Outdoor Air Temperature Entering Outdoor Coil									
	18°C		7°C		-4°C		-15°C		-26°C	
	Total Cool Cap.	Comp. Motor Input	Total Cool Cap.	Comp. Motor Input	Total Cool Cap.	Comp. Motor Input	Total Cool Cap.	Comp. Motor Input	Total Cool Cap.	Comp. Motor Input
	kW	kW	kW	kW	kW	kW	kW	kW	kW	kW
660	13.6	2.90	10.6	2.74	7.4	2.58	5.3	2.33	2.6	1.71
755	13.8	2.81	10.8	2.65	7.6	2.49	5.5	2.23	2.8	1.62
850	14.0	2.73	10.9	2.58	7.8	2.41	5.7	2.16	3.0	1.54

EXPANDED RATINGS - SINGLE PHASE MODELS

NOTE – For Temperatures and Capacities not shown in tables, see bulletin – Cooling Unit Rating Table Correction Factor Data in Miscellaneous Engineering Data section.

TPA048S4 Cooling Capacity with

CH33-48C-2F

Entering Wet Bulb Temperature	Total Air Volume	Outdoor Air Temperature Entering Outdoor Coil																			
		27°C						35°C					43°C					52°C			
		Total Cool Cap.	Comp. Motor Input	Sensible To Total Ratio (S/T)			Total Cool Cap.	Comp. Motor Input	Sensible To Total Ratio (S/T)			Total Cool Cap.	Comp. Motor Input	Sensible To Total Ratio (S/T)			Total Cool Cap.	Comp. Motor Input	Sensible To Total Ratio (S/T)		
				Dry Bulb					Dry Bulb					Dry Bulb					Dry Bulb		
L/s	kW	kW	24°C	27°C	29°C	kW	kW	24°C	27°C	29°C	kW	kW	24°C	27°C	29°C	kW	kW	24°C	27°C	29°C	
17°C	660	12.5	2.37	0.78	0.93	1.00	11.6	2.86	0.81	0.96	1.00	10.7	3.48	0.84	1.00	1.00	9.7	4.29	0.90	1.00	1.00
	755	12.9	2.37	0.82	0.97	1.00	12.0	2.86	0.84	1.00	1.00	11.0	3.48	0.89	1.00	1.00	10.0	4.29	0.94	1.00	1.00
	850	13.2	2.38	0.84	1.00	1.00	12.3	2.86	0.88	1.00	1.00	11.4	3.48	0.93	1.00	1.00	10.3	4.29	0.99	1.00	1.00
19°C	660	13.3	2.38	0.62	0.76	0.89	12.4	2.86	0.63	0.79	0.93	11.3	3.48	0.66	0.82	0.98	10.1	4.30	0.69	0.87	1.00
	755	13.6	2.38	0.64	0.79	0.94	12.7	2.87	0.66	0.82	0.97	11.6	3.48	0.68	0.86	1.00	10.3	4.29	0.72	0.92	1.00
	850	13.9	2.39	0.66	0.82	0.98	12.9	2.87	0.68	0.86	1.00	11.8	3.49	0.71	0.90	1.00	10.5	4.29	0.75	0.96	1.00
22°C	660	14.0	2.39	0.47	0.60	0.73	13.1	2.87	0.48	0.62	0.76	12.0	3.49	0.49	0.64	0.80	10.7	4.28	0.50	0.68	0.85
	755	14.3	2.40	0.48	0.63	0.77	13.4	2.88	0.49	0.65	0.80	12.3	3.49	0.50	0.67	0.84	10.9	4.29	0.52	0.71	0.89
	850	14.6	2.40	0.49	0.65	0.79	13.6	2.88	0.50	0.67	0.83	12.5	3.49	0.51	0.70	0.88	11.1	4.28	0.53	0.74	0.94

TPA048S4 Heating Capacity with

CH33-48C-2F

Indoor Coil Air Volume 21°C Dry Bulb	Outdoor Air Temperature Entering Outdoor Coil									
	18°C		7°C		-4°C		-15°C		-26°C	
	Total Cool Cap.	Comp. Motor Input	Total Cool Cap.	Comp. Motor Input	Total Cool Cap.	Comp. Motor Input	Total Cool Cap.	Comp. Motor Input	Total Cool Cap.	Comp. Motor Input
kW	kW	kW	kW	kW	kW	kW	kW	kW	kW	kW
660	13.7	2.82	10.7	2.67	7.4	2.52	5.4	2.27	2.7	1.67
755	13.9	2.72	10.9	2.57	7.6	2.42	5.5	2.18	2.8	1.58
850	14.1	2.65	11.0	2.50	7.8	2.35	5.7	2.10	3.0	1.50

TPA048S4 Cooling Capacity with

CR33-50/60C-F

Entering Wet Bulb Temperature	Total Air Volume	Outdoor Air Temperature Entering Outdoor Coil																			
		27°C						35°C					43°C					52°C			
		Total Cool Cap.	Comp. Motor Input	Sensible To Total Ratio (S/T)			Total Cool Cap.	Comp. Motor Input	Sensible To Total Ratio (S/T)			Total Cool Cap.	Comp. Motor Input	Sensible To Total Ratio (S/T)			Total Cool Cap.	Comp. Motor Input	Sensible To Total Ratio (S/T)		
				Dry Bulb					Dry Bulb					Dry Bulb					Dry Bulb		
L/s	kW	kW	24°C	27°C	29°C	kW	kW	24°C	27°C	29°C	kW	kW	24°C	27°C	29°C	kW	kW	24°C	27°C	29°C	
17°C	660	12.6	2.37	0.80	0.95	1.00	11.7	2.86	0.83	0.98	1.00	10.8	3.49	0.86	1.00	1.00	9.8	4.30	0.92	1.00	1.00
	755	12.9	2.37	0.83	0.99	1.00	12.1	2.86	0.87	1.00	1.00	11.2	3.49	0.91	1.00	1.00	10.2	4.29	0.97	1.00	1.00
	850	13.2	2.38	0.86	1.00	1.00	12.4	2.86	0.90	1.00	1.00	11.5	3.49	0.95	1.00	1.00	10.5	4.29	1.00	1.00	1.00
19°C	660	13.3	2.38	0.63	0.77	0.91	12.4	2.87	0.65	0.80	0.95	11.4	3.49	0.67	0.84	0.99	10.1	4.29	0.71	0.90	1.00
	755	13.6	2.39	0.65	0.81	0.96	12.7	2.87	0.67	0.84	0.99	11.6	3.48	0.70	0.89	1.00	10.3	4.28	0.74	0.95	1.00
	850	13.8	2.39	0.67	0.84	0.99	12.9	2.87	0.70	0.88	1.00	11.8	3.49	0.73	0.93	1.00	10.5	4.29	0.77	0.98	1.00
22°C	660	14.0	2.39	0.48	0.62	0.75	13.1	2.87	0.48	0.64	0.78	12.0	3.49	0.50	0.66	0.82	10.8	4.28	0.51	0.70	0.87
	755	14.3	2.40	0.49	0.64	0.79	13.3	2.88	0.50	0.66	0.82	12.3	3.49	0.51	0.69	0.86	11.0	4.29	0.53	0.73	0.92
	850	14.6	2.40	0.50	0.66	0.82	13.6	2.88	0.51	0.69	0.86	12.4	3.49	0.53	0.72	0.91	11.1	4.28	0.55	0.77	0.97

TPA048S4 Heating Capacity with

CR33-50/60C-F

Indoor Coil Air Volume 21°C Dry Bulb	Outdoor Air Temperature Entering Outdoor Coil									
	18°C		7°C		-4°C		-15°C		-26°C	
	Total Cool Cap.	Comp. Motor Input	Total Cool Cap.	Comp. Motor Input	Total Cool Cap.	Comp. Motor Input	Total Cool Cap.	Comp. Motor Input	Total Cool Cap.	Comp. Motor Input
kW	kW	kW	kW	kW	kW	kW	kW	kW	kW	kW
660	14.0	2.64	10.8	2.51	7.6	2.38	5.4	2.16	2.7	1.59
755	14.2	2.55	11.0	2.43	7.7	2.30	5.6	2.08	2.9	1.51
850	14.3	2.49	11.2	2.37	7.9	2.24	5.7	2.02	3.0	1.44

EXPANDED RATINGS - THREE PHASE MODELS

NOTE – For Temperatures and Capacities not shown in tables, see bulletin – Cooling Unit Rating Table Correction Factor Data in Miscellaneous Engineering Data section.

TPA036S4 Cooling Capacity with

BCRMB9937S005

Entering Wet Bulb Temperature	Total Air Volume	Outdoor Air Temperature Entering Outdoor Coil																							
		27°C						35°C						43°C						52°C					
		Total Cool Cap.	Comp. Motor Input	Sensible To Total Ratio (S/T)			Total Cool Cap.	Comp. Motor Input	Sensible To Total Ratio (S/T)			Total Cool Cap.	Comp. Motor Input	Sensible To Total Ratio (S/T)			Total Cool Cap.	Comp. Motor Input	Sensible To Total Ratio (S/T)						
				Dry Bulb					Dry Bulb					Dry Bulb					Dry Bulb						
L/s	kW	kW	24°C	27°C	29°C	kW	kW	24°C	27°C	29°C	kW	kW	24°C	27°C	29°C	kW	kW	24°C	27°C	29°C					
17°C	455	9.6	2.04	0.74	0.87	0.99	8.9	2.46	0.76	0.91	1.00	8.1	2.98	0.80	0.96	1.00	7.2	3.61	0.85	1.00	1.00				
	570	10.0	2.05	0.79	0.94	1.00	9.3	2.47	0.82	0.98	1.00	8.5	2.99	0.86	1.00	1.00	7.6	3.63	0.92	1.00	1.00				
	685	10.3	2.07	0.83	0.99	1.00	9.6	2.49	0.87	1.00	1.00	8.9	3.00	0.92	1.00	1.00	8.0	3.64	0.99	1.00	1.00				
19°C	455	10.1	2.06	0.59	0.72	0.84	9.4	2.48	0.60	0.74	0.87	8.6	2.99	0.62	0.77	0.92	7.6	3.63	0.65	0.82	0.98				
	570	10.6	2.07	0.62	0.76	0.91	9.8	2.49	0.64	0.79	0.95	8.9	3.00	0.66	0.84	1.00	7.9	3.64	0.70	0.90	1.00				
	685	10.9	2.08	0.64	0.81	0.97	10.1	2.50	0.67	0.85	1.00	9.1	3.02	0.70	0.90	1.00	8.1	3.65	0.74	0.97	1.00				
22°C	455	10.7	2.08	0.45	0.57	0.69	9.9	2.50	0.45	0.59	0.72	9.1	3.01	0.46	0.61	0.75	8.1	3.65	0.47	0.64	0.80				
	570	11.2	2.09	0.46	0.61	0.74	10.3	2.51	0.47	0.62	0.77	9.4	3.03	0.47	0.65	0.82	8.3	3.66	0.49	0.69	0.88				
	685	11.5	2.10	0.47	0.63	0.79	10.6	2.52	0.48	0.66	0.83	9.6	3.04	0.50	0.69	0.88	8.5	3.67	0.52	0.74	0.95				

TPA364S4 Heating Capacity with

BCRMB9937S005

Indoor Coil Air Volume 21°C Dry Bulb	Outdoor Air Temperature Entering Outdoor Coil									
	18°C		7°C		-4°C		-15°C		-26°C	
	Total Cool Cap.	Comp. Motor Input	Total Cool Cap.	Comp. Motor Input	Total Cool Cap.	Comp. Motor Input	Total Cool Cap.	Comp. Motor Input	Total Cool Cap.	Comp. Motor Input
	kW	kW	kW	kW	kW	kW	kW	kW	kW	kW
455	11.6	2.34	8.9	2.19	6.0	2.03	4.4	1.84	2.1	1.37
570	11.8	2.21	9.2	2.05	6.3	1.89	4.7	1.70	2.4	1.24
685	12.1	2.11	9.4	1.96	6.6	1.80	4.9	1.61	2.6	1.14

TPA036S4 Cooling Capacity with

CX34-38B-6F

Entering Wet Bulb Temperature	Total Air Volume	Outdoor Air Temperature Entering Outdoor Coil																							
		27°C						35°C						43°C						52°C					
		Total Cool Cap.	Comp. Motor Input	Sensible To Total Ratio (S/T)			Total Cool Cap.	Comp. Motor Input	Sensible To Total Ratio (S/T)			Total Cool Cap.	Comp. Motor Input	Sensible To Total Ratio (S/T)			Total Cool Cap.	Comp. Motor Input	Sensible To Total Ratio (S/T)						
				Dry Bulb					Dry Bulb					Dry Bulb					Dry Bulb						
L/s	kW	kW	24°C	27°C	29°C	kW	kW	24°C	27°C	29°C	kW	kW	24°C	27°C	29°C	kW	kW	24°C	27°C	29°C					
17°C	470	9.9	2.05	0.77	0.91	1.00	9.1	2.47	0.80	0.95	1.00	8.3	2.98	0.83	0.99	1.00	7.4	3.62	0.89	1.00	1.00				
	565	10.2	2.06	0.81	0.96	1.00	9.4	2.48	0.84	1.00	1.00	8.7	3.00	0.89	1.00	1.00	7.8	3.64	0.95	1.00	1.00				
	660	10.6	2.07	0.86	1.00	1.00	9.8	2.49	0.90	1.00	1.00	9.0	3.01	0.95	1.00	1.00	8.1	3.65	1.00	1.00	1.00				
19°C	470	10.5	2.07	0.61	0.74	0.87	9.7	2.49	0.63	0.77	0.91	8.8	3.00	0.65	0.81	0.96	7.8	3.64	0.69	0.87	1.00				
	565	10.8	2.08	0.64	0.79	0.93	10.0	2.50	0.66	0.82	0.98	9.0	3.01	0.68	0.87	1.00	8.0	3.65	0.72	0.93	1.00				
	660	11.1	2.09	0.67	0.84	0.99	10.2	2.51	0.69	0.88	1.00	9.2	3.02	0.72	0.93	1.00	8.1	3.65	0.77	0.99	1.00				
22°C	470	11.0	2.09	0.47	0.60	0.72	10.2	2.51	0.48	0.62	0.75	9.3	3.02	0.49	0.64	0.79	8.2	3.66	0.51	0.68	0.84				
	565	11.3	2.10	0.48	0.62	0.77	10.5	2.52	0.49	0.65	0.80	9.6	3.03	0.50	0.67	0.84	8.4	3.67	0.52	0.72	0.91				
	660	11.6	2.11	0.50	0.66	0.81	10.8	2.53	0.51	0.68	0.85	9.8	3.04	0.53	0.72	0.90	8.6	3.68	0.55	0.77	0.97				

TPA036S4 Heating Capacity with

CX34-38B-6F

Indoor Coil Air Volume 21°C Dry Bulb	Outdoor Air Temperature Entering Outdoor Coil									
	18°C		7°C		-4°C		-15°C		-26°C	
	Total Cool Cap.	Comp. Motor Input	Total Cool Cap.	Comp. Motor Input	Total Cool Cap.	Comp. Motor Input	Total Cool Cap.	Comp. Motor Input	Total Cool Cap.	Comp. Motor Input
	kW	kW	kW	kW	kW	kW	kW	kW	kW	kW
470	11.4	2.43	8.8	2.25	6.0	2.06	4.3	1.86	2.2	1.39
565	11.5	2.30	8.9	2.12	6.1	1.94	4.5	1.73	2.3	1.26
660	11.8	2.22	9.1	2.04	6.4	1.86	4.7	1.65	2.5	1.18

EXPANDED RATINGS - THREE PHASE MODELS

NOTE – For Temperatures and Capacities not shown in tables, see bulletin – Cooling Unit Rating Table Correction Factor Data in Miscellaneous Engineering Data section.

TPA036S4 Cooling Capacity with

CH33-36C-2F

Entering Wet Bulb Temperature	Total Air Volume	Outdoor Air Temperature Entering Outdoor Coil																							
		27°C						35°C						43°C						52°C					
		Total Cool Cap.	Comp. Motor Input	Sensible To Total Ratio (S/T)			Total Cool Cap.	Comp. Motor Input	Sensible To Total Ratio (S/T)			Total Cool Cap.	Comp. Motor Input	Sensible To Total Ratio (S/T)			Total Cool Cap.	Comp. Motor Input	Sensible To Total Ratio (S/T)						
				Dry Bulb					Dry Bulb					Dry Bulb					Dry Bulb						
L/s	kW	kW	24°C	27°C	29°C	kW	kW	24°C	27°C	29°C	kW	kW	24°C	27°C	29°C	kW	kW	24°C	27°C	29°C					
17°C	470	9.7	2.05	0.78	0.91	1.00	9.0	2.46	0.80	0.95	1.00	8.1	2.98	0.84	1.00	1.00	7.3	3.62	0.90	1.00	1.00				
	565	10.0	2.06	0.82	0.97	1.00	9.3	2.47	0.85	1.00	1.00	8.5	2.99	0.89	1.00	1.00	7.7	3.64	0.96	1.00	1.00				
	660	10.4	2.07	0.86	1.00	1.00	9.7	2.49	0.90	1.00	1.00	8.9	3.00	0.95	1.00	1.00	7.9	3.65	1.00	1.00	1.00				
19°C	470	10.2	2.06	0.62	0.75	0.88	9.4	2.48	0.64	0.78	0.92	8.6	2.99	0.66	0.82	0.97	7.6	3.63	0.69	0.87	1.00				
	565	10.6	2.07	0.64	0.79	0.94	9.7	2.49	0.66	0.83	0.98	8.9	3.00	0.69	0.87	1.00	7.8	3.64	0.73	0.94	1.00				
	660	10.8	2.08	0.67	0.84	0.99	10.0	2.50	0.70	0.88	1.00	9.1	3.01	0.73	0.93	1.00	8.0	3.65	0.78	1.00	1.00				
22°C	470	10.6	2.07	0.48	0.61	0.73	9.8	2.49	0.48	0.62	0.76	9.0	3.01	0.49	0.65	0.80	8.0	3.65	0.51	0.68	0.85				
	565	11.0	2.09	0.48	0.63	0.77	10.2	2.51	0.50	0.65	0.80	9.3	3.02	0.51	0.68	0.85	8.2	3.66	0.53	0.72	0.91				
	660	11.3	2.10	0.50	0.66	0.82	10.5	2.52	0.51	0.69	0.86	9.5	3.03	0.53	0.72	0.91	8.4	3.66	0.55	0.77	0.98				

TPA036S4 Heating Capacity with

CH33-36C-2F

Indoor Coil Air Volume 21°C Dry Bulb	Outdoor Air Temperature Entering Outdoor Coil									
	18°C		7°C		-4°C		-15°C		-26°C	
	Total Cool Cap.	Comp. Motor Input	Total Cool Cap.	Comp. Motor Input	Total Cool Cap.	Comp. Motor Input	Total Cool Cap.	Comp. Motor Input	Total Cool Cap.	Comp. Motor Input
	kW	kW	kW	kW	kW	kW	kW	kW	kW	kW
470	11.5	2.37	8.8	2.21	6.0	2.04	4.4	1.85	2.2	1.38
565	11.6	2.24	8.9	2.08	6.1	1.92	4.5	1.72	2.3	1.25
660	11.8	2.17	9.2	2.01	6.4	1.84	4.7	1.65	2.5	1.18

TPA036S4 Cooling Capacity with

CR33-30/36B-F

Entering Wet Bulb Temperature	Total Air Volume	Outdoor Air Temperature Entering Outdoor Coil																							
		27°C						35°C						43°C						52°C					
		Total Cool Cap.	Comp. Motor Input	Sensible To Total Ratio (S/T)			Total Cool Cap.	Comp. Motor Input	Sensible To Total Ratio (S/T)			Total Cool Cap.	Comp. Motor Input	Sensible To Total Ratio (S/T)			Total Cool Cap.	Comp. Motor Input	Sensible To Total Ratio (S/T)						
				Dry Bulb					Dry Bulb					Dry Bulb					Dry Bulb						
L/s	kW	kW	24°C	27°C	29°C	kW	kW	24°C	27°C	29°C	kW	kW	24°C	27°C	29°C	kW	kW	24°C	27°C	29°C					
17°C	470	9.7	2.04	0.77	0.91	1.00	8.9	2.46	0.80	0.95	1.00	8.1	2.98	0.84	0.99	1.00	7.3	3.62	0.89	1.00	1.00				
	565	10.0	2.06	0.81	0.96	1.00	9.3	2.47	0.85	1.00	1.00	8.5	2.99	0.89	1.00	1.00	7.6	3.63	0.95	1.00	1.00				
	660	10.3	2.06	0.86	1.00	1.00	9.6	2.49	0.90	1.00	1.00	8.8	3.00	0.94	1.00	1.00	7.9	3.64	1.00	1.00	1.00				
19°C	470	10.2	2.06	0.61	0.75	0.88	9.5	2.48	0.63	0.78	0.92	8.6	2.99	0.66	0.81	0.96	7.6	3.63	0.69	0.87	1.00				
	565	10.5	2.07	0.64	0.79	0.93	9.7	2.49	0.66	0.82	0.97	8.9	3.00	0.69	0.87	1.00	7.8	3.64	0.73	0.93	1.00				
	660	10.8	2.08	0.67	0.84	0.98	10.0	2.50	0.69	0.88	1.00	9.0	3.01	0.73	0.92	1.00	8.0	3.65	0.77	0.98	1.00				
22°C	470	10.7	2.08	0.47	0.60	0.72	9.9	2.50	0.48	0.62	0.75	9.1	3.01	0.49	0.64	0.79	8.0	3.65	0.51	0.68	0.85				
	565	11.1	2.09	0.48	0.63	0.77	10.3	2.51	0.49	0.65	0.80	9.3	3.02	0.50	0.68	0.85	8.2	3.66	0.52	0.72	0.91				
	660	11.4	2.10	0.50	0.66	0.82	10.5	2.52	0.51	0.68	0.85	9.5	3.03	0.53	0.72	0.90	8.4	3.67	0.55	0.77	0.97				

TPA036S4 Heating Capacity with

CR33-30/36B-F

Indoor Coil Air Volume 21°C Dry Bulb	Outdoor Air Temperature Entering Outdoor Coil									
	18°C		7°C		-4°C		-15°C		-26°C	
	Total Cool Cap.	Comp. Motor Input	Total Cool Cap.	Comp. Motor Input	Total Cool Cap.	Comp. Motor Input	Total Cool Cap.	Comp. Motor Input	Total Cool Cap.	Comp. Motor Input
	kW	kW	kW	kW	kW	kW	kW	kW	kW	kW
470	11.5	2.34	8.9	2.18	6.0	2.03	4.4	1.83	2.2	1.36
565	11.6	2.22	9.0	2.07	6.1	1.91	4.5	1.71	2.3	1.24
660	11.8	2.14	9.2	1.99	6.4	1.83	4.7	1.64	2.5	1.17

EXPANDED RATINGS - THREE PHASE MODELS

NOTE – For Temperatures and Capacities not shown in tables, see bulletin – Cooling Unit Rating Table Correction Factor Data in Miscellaneous Engineering Data section.

TPA048S4 Cooling Capacity with

BCRMC9960S005

Entering Wet Bulb Temperature	Total Air Volume	Outdoor Air Temperature Entering Outdoor Coil																							
		27°C						35°C						43°C						52°C					
		Total Cool Cap.	Comp. Motor Input	Sensible To Total Ratio (S/T)			Total Cool Cap.	Comp. Motor Input	Sensible To Total Ratio (S/T)			Total Cool Cap.	Comp. Motor Input	Sensible To Total Ratio (S/T)			Total Cool Cap.	Comp. Motor Input	Sensible To Total Ratio (S/T)						
				Dry Bulb					Dry Bulb					Dry Bulb					Dry Bulb						
L/s	kW	kW	24°C	27°C	29°C	kW	kW	24°C	27°C	29°C	kW	kW	24°C	27°C	29°C	kW	kW	24°C	27°C	29°C					
17°C	575	12.0	2.25	0.75	0.89	1.00	11.1	2.73	0.77	0.92	1.00	10.2	3.35	0.81	0.97	1.00	9.1	4.16	0.86	1.00	1.00				
	715	12.5	2.26	0.80	0.96	1.00	11.7	2.73	0.83	0.99	1.00	10.8	3.35	0.87	1.00	1.00	9.8	4.15	0.93	1.00	1.00				
	860	13.0	2.27	0.85	1.00	1.00	12.3	2.74	0.89	1.00	1.00	11.3	3.35	0.94	1.00	1.00	10.2	4.14	0.99	1.00	1.00				
19°C	575	12.7	2.26	0.59	0.73	0.85	11.9	2.74	0.61	0.75	0.89	10.8	3.35	0.63	0.78	0.93	9.7	4.14	0.65	0.83	0.99				
	715	13.3	2.27	0.62	0.78	0.92	12.4	2.74	0.64	0.81	0.96	11.3	3.35	0.67	0.85	1.00	10.1	4.15	0.70	0.91	1.00				
	860	13.7	2.28	0.65	0.82	0.98	12.7	2.75	0.68	0.86	1.00	11.6	3.36	0.70	0.91	1.00	10.3	4.13	0.75	0.97	1.00				
22°C	575	13.5	2.27	0.45	0.58	0.70	12.6	2.75	0.45	0.59	0.72	11.5	3.36	0.46	0.61	0.76	10.3	4.14	0.47	0.64	0.80				
	715	14.1	2.28	0.47	0.61	0.75	13.1	2.76	0.47	0.63	0.78	12.0	3.36	0.48	0.65	0.82	10.7	4.13	0.49	0.69	0.88				
	860	14.5	2.29	0.48	0.64	0.80	13.5	2.76	0.49	0.67	0.84	12.3	3.36	0.50	0.70	0.89	11.0	4.13	0.52	0.74	0.95				

TPA048S4 Heating Capacity with

BCRMC9960S005

Indoor Coil Air Volume 21°C Dry Bulb	Outdoor Air Temperature Entering Outdoor Coil									
	18°C		7°C		-4°C		-15°C		-26°C	
	Total Cool Cap.	Comp. Motor Input	Total Cool Cap.	Comp. Motor Input	Total Cool Cap.	Comp. Motor Input	Total Cool Cap.	Comp. Motor Input	Total Cool Cap.	Comp. Motor Input
	kW	kW	kW	kW	kW	kW	kW	kW	kW	kW
575	13.9	2.54	10.7	2.42	7.4	2.29	5.2	2.08	2.5	1.55
715	14.2	2.39	11.0	2.27	7.7	2.14	5.6	1.93	2.9	1.40
860	14.5	2.30	11.3	2.17	8.0	2.05	5.9	1.83	3.2	1.30

TPA048S4 Cooling Capacity with

CX34-44/48C-6F

Entering Wet Bulb Temperature	Total Air Volume	Outdoor Air Temperature Entering Outdoor Coil																							
		27°C						35°C						43°C						52°C					
		Total Cool Cap.	Comp. Motor Input	Sensible To Total Ratio (S/T)			Total Cool Cap.	Comp. Motor Input	Sensible To Total Ratio (S/T)			Total Cool Cap.	Comp. Motor Input	Sensible To Total Ratio (S/T)			Total Cool Cap.	Comp. Motor Input	Sensible To Total Ratio (S/T)						
				Dry Bulb					Dry Bulb					Dry Bulb					Dry Bulb						
L/s	kW	kW	24°C	27°C	29°C	kW	kW	24°C	27°C	29°C	kW	kW	24°C	27°C	29°C	kW	kW	24°C	27°C	29°C					
17°C	660	12.3	2.26	0.78	0.92	1.00	11.4	2.73	0.81	0.96	1.00	10.4	3.35	0.84	1.00	1.00	9.4	4.14	0.90	1.00	1.00				
	755	12.6	2.26	0.81	0.96	1.00	11.7	2.74	0.84	1.00	1.00	10.8	3.36	0.88	1.00	1.00	9.7	4.15	0.94	1.00	1.00				
	850	12.9	2.26	0.84	0.99	1.00	12.0	2.74	0.87	1.00	1.00	11.1	3.36	0.92	1.00	1.00	10.0	4.14	0.98	1.00	1.00				
19°C	660	13.0	2.27	0.62	0.75	0.89	12.1	2.74	0.63	0.78	0.92	11.0	3.35	0.66	0.82	0.97	9.9	4.15	0.69	0.87	1.00				
	755	13.3	2.27	0.64	0.79	0.93	12.4	2.74	0.66	0.82	0.97	11.3	3.35	0.68	0.86	1.00	10.0	4.13	0.72	0.92	1.00				
	850	13.5	2.27	0.66	0.82	0.97	12.6	2.75	0.68	0.85	1.00	11.5	3.36	0.70	0.90	1.00	10.2	4.14	0.75	0.96	1.00				
22°C	660	13.7	2.27	0.47	0.60	0.73	12.8	2.75	0.48	0.62	0.76	11.7	3.36	0.49	0.64	0.79	10.5	4.14	0.50	0.68	0.84				
	755	14.1	2.28	0.48	0.62	0.76	13.1	2.75	0.49	0.64	0.79	12.0	3.35	0.50	0.67	0.83	10.7	4.12	0.52	0.71	0.89				
	850	14.3	2.29	0.49	0.64	0.80	13.3	2.76	0.50	0.67	0.83	12.2	3.36	0.51	0.69	0.87	10.9	4.14	0.53	0.74	0.93				

TPA048S4 Heating Capacity with

CX34-44/48C-6F

Indoor Coil Air Volume 21°C Dry Bulb	Outdoor Air Temperature Entering Outdoor Coil									
	18°C		7°C		-4°C		-15°C		-26°C	
	Total Cool Cap.	Comp. Motor Input	Total Cool Cap.	Comp. Motor Input	Total Cool Cap.	Comp. Motor Input	Total Cool Cap.	Comp. Motor Input	Total Cool Cap.	Comp. Motor Input
	kW	kW	kW	kW	kW	kW	kW	kW	kW	kW
660	13.4	2.77	10.4	2.61	7.2	2.45	5.1	2.20	2.5	1.63
755	13.6	2.67	10.6	2.52	7.3	2.36	5.3	2.11	2.7	1.53
850	13.7	2.60	10.7	2.45	7.5	2.28	5.5	2.04	2.9	1.46

EXPANDED RATINGS - THREE PHASE MODELS

NOTE – For Temperatures and Capacities not shown in tables, see bulletin – Cooling Unit Rating Table Correction Factor Data in Miscellaneous Engineering Data section.

TPA048S4 Cooling Capacity with

CH33-48C-2F

Entering Wet Bulb Temperature	Total Air Volume	Outdoor Air Temperature Entering Outdoor Coil																							
		27°C						35°C						43°C						52°C					
		Total Cool Cap.	Comp. Motor Input	Sensible To Total Ratio (S/T)			Total Cool Cap.	Comp. Motor Input	Sensible To Total Ratio (S/T)			Total Cool Cap.	Comp. Motor Input	Sensible To Total Ratio (S/T)			Total Cool Cap.	Comp. Motor Input	Sensible To Total Ratio (S/T)						
				Dry Bulb					Dry Bulb					Dry Bulb					Dry Bulb						
L/s	kW	kW	24°C	27°C	29°C	kW	kW	24°C	27°C	29°C	kW	kW	24°C	27°C	29°C	kW	kW	24°C	27°C	29°C					
17°C	660	12.4	2.26	0.79	0.93	1.00	11.5	2.73	0.81	0.97	1.00	10.6	3.35	0.85	1.00	1.00	9.6	4.14	0.91	1.00	1.00				
	755	12.7	2.26	0.82	0.97	1.00	11.8	2.74	0.85	1.00	1.00	11.0	3.35	0.89	1.00	1.00	9.9	4.15	0.95	1.00	1.00				
	850	13.0	2.27	0.85	1.00	1.00	12.2	2.74	0.88	1.00	1.00	11.3	3.35	0.93	1.00	1.00	10.2	4.14	0.99	1.00	1.00				
19°C	660	13.2	2.27	0.62	0.76	0.89	12.3	2.74	0.64	0.79	0.93	11.2	3.35	0.66	0.83	0.98	10.0	4.15	0.69	0.88	1.00				
	755	13.5	2.27	0.65	0.80	0.94	12.5	2.75	0.66	0.82	0.98	11.4	3.35	0.69	0.87	1.00	10.2	4.14	0.72	0.93	1.00				
	850	13.7	2.28	0.66	0.83	0.98	12.7	2.75	0.68	0.86	1.00	11.6	3.35	0.71	0.91	1.00	10.3	4.14	0.75	0.97	1.00				
22°C	660	13.9	2.28	0.47	0.60	0.74	13.0	2.75	0.48	0.62	0.76	11.9	3.35	0.49	0.65	0.80	10.6	4.14	0.51	0.68	0.85				
	755	14.2	2.28	0.48	0.63	0.77	13.3	2.76	0.49	0.65	0.80	12.1	3.36	0.50	0.67	0.84	10.8	4.13	0.52	0.71	0.90				
	850	14.5	2.29	0.49	0.65	0.80	13.5	2.76	0.50	0.67	0.84	12.3	3.36	0.52	0.70	0.88	11.0	4.13	0.54	0.75	0.95				

TPA048S4 Heating Capacity with

CH33-48C-2F

Indoor Coil Air Volume 21°C Dry Bulb	Outdoor Air Temperature Entering Outdoor Coil									
	18°C		7°C		-4°C		-15°C		-26°C	
	Total Cool Cap.	Comp. Motor Input	Total Cool Cap.	Comp. Motor Input	Total Cool Cap.	Comp. Motor Input	Total Cool Cap.	Comp. Motor Input	Total Cool Cap.	Comp. Motor Input
kW	kW	kW	kW	kW	kW	kW	kW	kW	kW	kW
660	13.5	2.68	10.5	2.53	7.2	2.39	5.1	2.15	2.5	1.58
755	13.7	2.59	10.6	2.44	7.4	2.29	5.3	2.06	2.7	1.49
850	13.9	2.51	10.8	2.37	7.6	2.22	5.5	1.99	2.9	1.42

TPA048S4 Cooling Capacity with

CR33-50/60C-F

Entering Wet Bulb Temperature	Total Air Volume	Outdoor Air Temperature Entering Outdoor Coil																							
		27°C						35°C						43°C						52°C					
		Total Cool Cap.	Comp. Motor Input	Sensible To Total Ratio (S/T)			Total Cool Cap.	Comp. Motor Input	Sensible To Total Ratio (S/T)			Total Cool Cap.	Comp. Motor Input	Sensible To Total Ratio (S/T)			Total Cool Cap.	Comp. Motor Input	Sensible To Total Ratio (S/T)						
				Dry Bulb					Dry Bulb					Dry Bulb					Dry Bulb						
L/s	kW	kW	24°C	27°C	29°C	kW	kW	24°C	27°C	29°C	kW	kW	24°C	27°C	29°C	kW	kW	24°C	27°C	29°C					
17°C	660	12.4	2.26	0.80	0.95	1.00	11.6	2.74	0.83	0.98	1.00	10.7	3.35	0.87	1.00	1.00	9.7	4.14	0.93	1.00	1.00				
	755	12.7	2.26	0.83	0.99	1.00	12.0	2.74	0.87	1.00	1.00	11.1	3.36	0.92	1.00	1.00	10.1	4.14	0.97	1.00	1.00				
	850	13.1	2.27	0.87	1.00	1.00	12.3	2.74	0.91	1.00	1.00	11.4	3.36	0.96	1.00	1.00	10.3	4.13	1.00	1.00	1.00				
19°C	660	13.2	2.27	0.63	0.78	0.92	12.3	2.74	0.65	0.81	0.96	11.2	3.35	0.68	0.85	0.99	10.0	4.15	0.71	0.90	1.00				
	755	13.5	2.27	0.65	0.81	0.96	12.5	2.75	0.68	0.85	0.99	11.5	3.35	0.70	0.89	1.00	10.2	4.13	0.75	0.95	1.00				
	850	13.7	2.28	0.68	0.85	0.99	12.7	2.75	0.70	0.89	1.00	11.7	3.35	0.73	0.93	1.00	10.4	4.14	0.78	0.99	1.00				
22°C	660	13.9	2.28	0.48	0.62	0.75	13.0	2.75	0.49	0.64	0.78	11.9	3.36	0.50	0.66	0.82	10.6	4.12	0.51	0.70	0.88				
	755	14.2	2.28	0.49	0.64	0.79	13.2	2.76	0.50	0.66	0.82	12.1	3.36	0.51	0.69	0.87	10.8	4.13	0.53	0.74	0.93				
	850	14.5	2.29	0.50	0.67	0.82	13.5	2.76	0.51	0.69	0.86	12.3	3.36	0.52	0.72	0.91	11.0	4.13	0.55	0.77	0.97				

TPA048S4 Heating Capacity with

CR33-50/60C-F

Indoor Coil Air Volume 21°C Dry Bulb	Outdoor Air Temperature Entering Outdoor Coil									
	18°C		7°C		-4°C		-15°C		-26°C	
	Total Cool Cap.	Comp. Motor Input	Total Cool Cap.	Comp. Motor Input	Total Cool Cap.	Comp. Motor Input	Total Cool Cap.	Comp. Motor Input	Total Cool Cap.	Comp. Motor Input
kW	kW	kW	kW	kW	kW	kW	kW	kW	kW	kW
660	13.8	2.51	10.6	2.38	7.3	2.26	5.2	2.04	2.6	1.50
755	14.0	2.43	10.8	2.31	7.5	2.18	5.4	1.97	2.8	1.42
850	14.1	2.37	10.9	2.25	7.6	2.12	5.5	1.91	2.9	1.36

EXPANDED RATINGS - THREE PHASE MODELS

NOTE – For Temperatures and Capacities not shown in tables, see bulletin – Cooling Unit Rating Table Correction Factor Data in Miscellaneous Engineering Data section.

TPA060S4 Cooling Capacity with

BCRMD1960S005

Entering Wet Bulb Temperature	Total Air Volume	Outdoor Air Temperature Entering Outdoor Coil																							
		27°C						35°C						43°C						52°C					
		Total Cool Cap.	Comp. Motor Input	Sensible To Total Ratio (S/T)			Total Cool Cap.	Comp. Motor Input	Sensible To Total Ratio (S/T)			Total Cool Cap.	Comp. Motor Input	Sensible To Total Ratio (S/T)			Total Cool Cap.	Comp. Motor Input	Sensible To Total Ratio (S/T)						
				Dry Bulb					Dry Bulb					Dry Bulb					Dry Bulb						
L/s	kW	kW	24°C	27°C	29°C	kW	kW	24°C	27°C	29°C	kW	kW	24°C	27°C	29°C	kW	kW	24°C	27°C	29°C					
17°C	640	14.7	2.95	0.72	0.84	0.96	13.7	3.60	0.74	0.87	0.99	12.6	4.43	0.76	0.91	1.00	11.2	5.47	0.80	0.96	1.00				
	800	15.4	2.99	0.76	0.90	1.00	14.4	3.64	0.78	0.94	1.00	13.2	4.45	0.82	0.98	1.00	11.9	5.50	0.87	1.00	1.00				
	960	16.0	3.02	0.80	0.96	1.00	14.9	3.66	0.83	0.99	1.00	13.8	4.47	0.87	1.00	1.00	12.5	5.52	0.93	1.00	1.00				
19°C	640	15.6	3.00	0.58	0.69	0.81	14.5	3.64	0.59	0.71	0.84	13.4	4.46	0.60	0.74	0.87	11.9	5.49	0.63	0.78	0.93				
	800	16.3	3.03	0.60	0.74	0.87	15.2	3.68	0.62	0.76	0.90	14.0	4.49	0.63	0.79	0.95	12.4	5.53	0.66	0.84	1.00				
	960	16.9	3.06	0.62	0.78	0.92	15.7	3.71	0.64	0.81	0.96	14.4	4.51	0.66	0.85	1.00	12.8	5.54	0.70	0.91	1.00				
22°C	640	16.5	3.04	0.44	0.56	0.67	15.4	3.69	0.45	0.57	0.69	14.2	4.49	0.45	0.59	0.71	12.7	5.53	0.46	0.61	0.75				
	800	17.3	3.08	0.46	0.59	0.71	16.1	3.73	0.46	0.60	0.74	14.8	4.54	0.47	0.62	0.77	13.2	5.57	0.48	0.65	0.82				
	960	17.8	3.11	0.47	0.61	0.76	16.6	3.76	0.48	0.63	0.78	15.2	4.56	0.48	0.66	0.83	13.5	5.57	0.50	0.69	0.88				

TPA060S4 Heating Capacity with

BCRMD1960S005

Indoor Coil Air Volume 21°C Dry Bulb	Outdoor Air Temperature Entering Outdoor Coil									
	18°C		7°C		-4°C		-15°C		-26°C	
	Total Cool Cap.	Comp. Motor Input	Total Cool Cap.	Comp. Motor Input	Total Cool Cap.	Comp. Motor Input	Total Cool Cap.	Comp. Motor Input	Total Cool Cap.	Comp. Motor Input
	kW	kW	kW	kW	kW	kW	kW	kW	kW	kW
640	17.1	3.46	13.1	3.18	8.9	2.89	6.5	2.56	3.2	1.94
800	17.5	3.21	13.5	2.93	9.3	2.64	6.9	2.32	3.5	1.70
960	17.8	3.05	13.9	2.77	9.6	2.48	7.3	2.16	3.9	1.54

TPA060S4 Cooling Capacity with

CX34-62D-6F

Entering Wet Bulb Temperature	Total Air Volume	Outdoor Air Temperature Entering Outdoor Coil																							
		27°C						35°C						43°C						52°C					
		Total Cool Cap.	Comp. Motor Input	Sensible To Total Ratio (S/T)			Total Cool Cap.	Comp. Motor Input	Sensible To Total Ratio (S/T)			Total Cool Cap.	Comp. Motor Input	Sensible To Total Ratio (S/T)			Total Cool Cap.	Comp. Motor Input	Sensible To Total Ratio (S/T)						
				Dry Bulb					Dry Bulb					Dry Bulb					Dry Bulb						
L/s	kW	kW	24°C	27°C	29°C	kW	kW	24°C	27°C	29°C	kW	kW	24°C	27°C	29°C	kW	kW	24°C	27°C	29°C					
17°C	660	15.0	2.97	0.74	0.86	0.98	14.0	3.62	0.76	0.89	1.00	12.8	4.44	0.79	0.93	1.00	11.5	5.48	0.83	0.99	1.00				
	755	15.5	2.99	0.76	0.90	1.00	14.4	3.63	0.79	0.93	1.00	13.2	4.45	0.82	0.98	1.00	11.9	5.49	0.87	1.00	1.00				
	850	15.9	3.01	0.79	0.93	1.00	14.8	3.66	0.82	0.97	1.00	13.5	4.47	0.85	1.00	1.00	12.3	5.51	0.91	1.00	1.00				
19°C	660	15.8	3.00	0.60	0.71	0.83	14.7	3.65	0.60	0.73	0.86	13.5	4.46	0.62	0.76	0.90	12.1	5.51	0.65	0.81	0.96				
	755	16.3	3.03	0.61	0.74	0.86	15.2	3.68	0.62	0.76	0.90	14.0	4.49	0.65	0.80	0.94	12.4	5.51	0.68	0.84	1.00				
	850	16.7	3.05	0.62	0.77	0.90	15.5	3.70	0.64	0.79	0.94	14.2	4.50	0.66	0.83	0.98	12.7	5.53	0.70	0.88	1.00				
22°C	660	16.6	3.05	0.46	0.58	0.69	15.5	3.70	0.47	0.60	0.71	14.3	4.50	0.47	0.61	0.74	12.8	5.53	0.49	0.63	0.78				
	755	17.0	3.07	0.47	0.59	0.71	15.9	3.72	0.47	0.61	0.74	14.7	4.52	0.49	0.63	0.77	13.1	5.56	0.50	0.66	0.82				
	850	17.4	3.09	0.48	0.61	0.74	16.3	3.74	0.48	0.63	0.77	15.0	4.54	0.50	0.65	0.80	13.4	5.56	0.51	0.68	0.85				

TPA060S4 Heating Capacity with

CX34-62D-6F

Indoor Coil Air Volume 21°C Dry Bulb	Outdoor Air Temperature Entering Outdoor Coil									
	18°C		7°C		-4°C		-15°C		-26°C	
	Total Cool Cap.	Comp. Motor Input	Total Cool Cap.	Comp. Motor Input	Total Cool Cap.	Comp. Motor Input	Total Cool Cap.	Comp. Motor Input	Total Cool Cap.	Comp. Motor Input
	kW	kW	kW	kW	kW	kW	kW	kW	kW	kW
660	16.5	3.80	12.7	3.44	29.6	8.7	3.07	6.4	2.72	3.2
755	16.7	3.63	13.0	3.27	30.4	8.9	2.90	6.6	2.55	3.4
850	16.9	3.51	13.1	3.15	31.0	9.1	2.77	6.8	2.42	3.5

EXPANDED RATINGS - THREE PHASE MODELS

NOTE – For Temperatures and Capacities not shown in tables, see bulletin – Cooling Unit Rating Table Correction Factor Data in Miscellaneous Engineering Data section.

TPA060S4 Cooling Capacity with

CH33-62D-2F

Entering Wet Bulb Temperature	Total Air Volume	Outdoor Air Temperature Entering Outdoor Coil																							
		27°C						35°C						43°C						52°C					
		Total Cool Cap.	Comp. Motor Input	Sensible To Total Ratio (S/T)			Total Cool Cap.	Comp. Motor Input	Sensible To Total Ratio (S/T)			Total Cool Cap.	Comp. Motor Input	Sensible To Total Ratio (S/T)			Total Cool Cap.	Comp. Motor Input	Sensible To Total Ratio (S/T)						
				Dry Bulb					Dry Bulb					Dry Bulb					Dry Bulb						
L/s	kW	kW	24°C	27°C	29°C	kW	kW	24°C	27°C	29°C	kW	kW	24°C	27°C	29°C	kW	kW	24°C	27°C	29°C					
17°C	660	14.9	2.96	0.73	0.85	0.97	13.9	3.61	0.75	0.88	1.00	12.7	4.43	0.78	0.92	1.00	11.3	5.48	0.82	0.98	1.00				
	755	15.3	2.98	0.76	0.89	1.00	14.3	3.63	0.78	0.92	1.00	13.1	4.44	0.81	0.97	1.00	11.7	5.49	0.86	1.00	1.00				
	850	15.7	3.00	0.78	0.92	1.00	14.6	3.65	0.81	0.96	1.00	13.4	4.46	0.84	1.00	1.00	12.1	5.50	0.89	1.00	1.00				
19°C	660	15.7	3.00	0.59	0.71	0.82	14.6	3.65	0.60	0.73	0.85	13.5	4.46	0.62	0.76	0.89	12.0	5.51	0.65	0.80	0.94				
	755	16.1	3.02	0.61	0.73	0.85	15.1	3.67	0.62	0.75	0.89	13.8	4.48	0.64	0.79	0.93	12.4	5.52	0.67	0.83	0.99				
	850	16.6	3.04	0.62	0.76	0.89	15.4	3.69	0.64	0.78	0.92	14.2	4.50	0.66	0.82	0.97	12.6	5.52	0.69	0.87	1.00				
22°C	660	16.5	3.04	0.46	0.57	0.68	15.4	3.69	0.47	0.59	0.70	14.2	4.50	0.47	0.60	0.73	12.7	5.53	0.49	0.63	0.77				
	755	16.9	3.06	0.47	0.59	0.71	15.8	3.71	0.47	0.61	0.73	14.6	4.52	0.48	0.63	0.76	13.0	5.56	0.50	0.66	0.81				
	850	17.3	3.09	0.48	0.61	0.73	16.2	3.73	0.48	0.62	0.76	14.9	4.54	0.49	0.65	0.79	13.3	5.55	0.51	0.68	0.84				

TPA060S4 Heating Capacity with

CH33-62D-2F

Indoor Coil Air Volume 21°C Dry Bulb	Outdoor Air Temperature Entering Outdoor Coil									
	18°C		7°C		-4°C		-15°C		-26°C	
	Total Cool Cap.	Comp. Motor Input	Total Cool Cap.	Comp. Motor Input	Total Cool Cap.	Comp. Motor Input	Total Cool Cap.	Comp. Motor Input	Total Cool Cap.	Comp. Motor Input
	kW	kW	kW	kW	kW	kW	kW	kW	kW	kW
660	16.5	3.86	12.7	3.49	8.7	3.10	6.4	2.73	3.1	1.89
755	16.7	3.69	12.9	3.32	8.9	2.93	6.6	2.56	3.4	1.80
850	16.9	3.56	13.1	3.19	9.1	2.80	6.8	2.43	3.5	1.71

TPA060S4 Cooling Capacity with

CR33-60D-F

Entering Wet Bulb Temperature	Total Air Volume	Outdoor Air Temperature Entering Outdoor Coil																							
		27°C						35°C						43°C						52°C					
		Total Cool Cap.	Comp. Motor Input	Sensible To Total Ratio (S/T)			Total Cool Cap.	Comp. Motor Input	Sensible To Total Ratio (S/T)			Total Cool Cap.	Comp. Motor Input	Sensible To Total Ratio (S/T)			Total Cool Cap.	Comp. Motor Input	Sensible To Total Ratio (S/T)						
				Dry Bulb					Dry Bulb					Dry Bulb					Dry Bulb						
L/s	kW	kW	24°C	27°C	29°C	kW	kW	24°C	27°C	29°C	kW	kW	24°C	27°C	29°C	kW	kW	24°C	27°C	29°C					
17°C	660	14.4	2.94	0.74	0.87	0.98	13.5	3.59	0.76	0.90	1.00	12.4	4.42	0.79	0.94	1.00	11.1	5.48	0.84	0.99	1.00				
	755	14.8	2.96	0.77	0.90	1.00	13.8	3.61	0.79	0.94	1.00	12.7	4.42	0.82	0.98	1.00	11.5	5.47	0.87	1.00	1.00				
	850	15.1	2.97	0.79	0.94	1.00	14.1	3.62	0.82	0.97	1.00	13.1	4.44	0.85	1.00	1.00	11.9	5.50	0.91	1.00	1.00				
19°C	660	15.2	2.98	0.60	0.72	0.83	14.3	3.63	0.62	0.74	0.86	13.1	4.44	0.63	0.77	0.90	11.8	5.50	0.66	0.81	0.96				
	755	15.7	3.00	0.62	0.74	0.87	14.6	3.65	0.63	0.77	0.90	13.5	4.45	0.65	0.80	0.95	12.0	5.51	0.68	0.85	0.99				
	850	16.0	3.01	0.63	0.77	0.90	14.9	3.66	0.65	0.79	0.94	13.7	4.47	0.67	0.83	0.98	12.2	5.50	0.70	0.89	1.00				
22°C	660	16.0	3.02	0.47	0.59	0.70	15.0	3.67	0.47	0.60	0.72	13.9	4.48	0.48	0.62	0.74	12.4	5.52	0.49	0.64	0.79				
	755	16.5	3.04	0.47	0.60	0.72	15.4	3.69	0.48	0.62	0.74	14.2	4.49	0.49	0.64	0.78	12.7	5.54	0.51	0.67	0.82				
	850	16.9	3.06	0.48	0.62	0.75	15.7	3.70	0.49	0.63	0.77	14.5	4.51	0.50	0.66	0.81	13.0	5.55	0.52	0.69	0.86				

TPA060S4 Heating Capacity with

CR33-60D-F

Indoor Coil Air Volume 21°C Dry Bulb	Outdoor Air Temperature Entering Outdoor Coil									
	18°C		7°C		-4°C		-15°C		-26°C	
	Total Cool Cap.	Comp. Motor Input	Total Cool Cap.	Comp. Motor Input	Total Cool Cap.	Comp. Motor Input	Total Cool Cap.	Comp. Motor Input	Total Cool Cap.	Comp. Motor Input
	kW	kW	kW	kW	kW	kW	kW	kW	kW	kW
660	16.7	3.62	12.9	3.28	8.8	2.93	6.4	2.58	3.2	1.80
755	16.9	3.48	13.1	3.14	9.0	2.79	6.6	2.44	3.4	1.72
850	17.1	3.37	13.2	3.03	9.1	2.68	6.8	2.33	3.5	1.65

REVISIONS

Specifications	Updated electrical data on all. Update refrigerant charge on all except TPA024 and TPA060
Ratings Expanded ratings	Corrected model numbers for air handlers.



Visit us at www.lennox.com

For the latest technical information, www.lennoxcommercial.com

Contact us at 1-800-4-LENNOX

NOTE - Due to Lennox' ongoing commitment to quality, Specifications, Ratings and Dimensions subject to change without notice and without incurring liability. Improper installation, adjustment, alteration, service or maintenance can cause property damage or personal injury. Installation and service must be performed by a qualified installer and servicing agency.

©2009 Lennox Industries, Inc.